

LÜFTNER CRUISES



RIVER CRUISES

2024

RHINE · MAIN · MOSELLE · SAAR | DANUBE | SEINE | RHÔNE · SAÔNE
THE DUTCH AND BELGIAN WATERWAYS



Dear Readers and Travel Enthusiasts,

We look forward to another year of cruising the most beautiful routes on European rivers and to introducing the latest advancements in sustainable technology to our next generation of river cruise ships. As a traditional, family-owned, Austrian company, we focus on hospitality and care about the environment. As we cruise through "our own backyard", we utilize the latest state-of-the-art systems and onboard technology to maintain and sustain the rivers and environments around us.

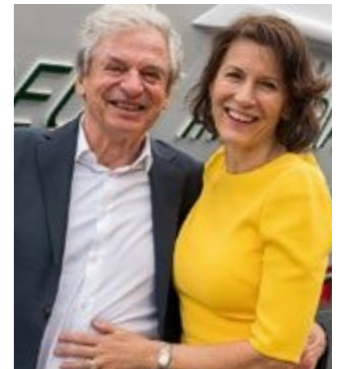

In the spring of 2024, we look forward to welcoming the AMADEUS Nova to our fleet. The AMADEUS Nova is scheduled to cruise the Rhine, Main and Danube rivers and will be the first in a new class of ships that will focus on incorporating upgraded environmentally sustainable features such as hybrid diesel-electric propulsion systems. The ship is designed to reduce emissions and improve operational efficiency, but her guests can also expect an enhanced passenger experience onboard.

Our commitment to maintain our role as leaders in luxury European River Cruising is stronger than ever. With every new ship we celebrate the evolution of our fleet as we continue our 40-year tradition of innovation and excellence with a focus on state-of-the-art cabin design, modern elegance, and luxurious comfort. From our spacious cabins featuring walk-in closets and panorama drop down windows to spacious and elegantly designed public spaces onboard our vessels it is all about your onboard experience and ultimate comfort as we introduce you to our European heritage and hospitality.

Make 2024 the year to rediscover Europe along our legendary itineraries as you cruise past breathtaking riverbanks: on the Rhine and Danube or through Burgundy and Provence in the south of France. Follow the fabled Seine River from Paris to Normandy. Marvel at the beauties of this world on Dutch and Belgian Waterways, or in the Danube Delta and on the shores of the Black Sea. In addition, we feature an interesting portfolio of theme cruises including: Golf, Advent, Christmas and New Year's cruises; each offering those rare experiences not to be missed.

Enjoy the luxury of river cruise with our AMADEUS fleet and discover one of our 28 different itineraries. We look forward to welcoming you on board one of our award-winning vessels in the near future!

Dr. Wolfgang Lüftner and Martina Lüftner
and the AMADEUS Team

Our River Cruises at a Glance



Content

Travel the AMADEUS Way	6–15
Our Overview of the AMADEUS Services	16–17
AMADEUS Cruiser Club	18–19
Rhine · Main · Moselle · Saar, the Dutch and Belgian Waterways	20
Tulip Serenade	22
8 days Amsterdam – Ghent – Amsterdam	
Classical Rhine	26
8 days Basel – Amsterdam or Amsterdam – Basel With "Rhine in Flames®" tour date Aug 7, 2024	
Three-Rivers Cruise	32
8 days Nuremberg – Amsterdam	
Saar and Moselle Fairytales	36
8 days Cologne – Saarlouis – Cologne	
Rhine and Danube Symphony	40
8 days Cologne – Passau or Passau – Cologne	
German Riverscapes	46
9 days Trier – Passau or Passau – Trier	
Across Europe	52
15 days Amsterdam – Budapest	
Danube · Danube Delta	56
Classical Danube	58
8 days Budapest – Passau or Passau – Budapest	
Danube Rhapsody	64
8 days Passau – Budapest – Passau	
Blue Danube	68
8 days Nuremberg – Budapest	
Beautiful Blue Danube and Danube Delta	72
16 days Passau – Danube Delta – Passau	
1,200 Miles on the Beautiful Blue Danube	76
10 days Vienna – Danube Delta – Bucharest or 11 days Bucharest – Danube Delta – Vienna	
France: Seine, Rhône · Saône	82
Paris, Normandy and the River Seine	84
8 days Paris – Le Havre – Paris	
Treasures of Burgundy and Provence	88
8 days Lyon – Chalon-sur-Saône – Arles – Lyon	
Themed Cruises	92
Golf Cruises: Rhine, Danube and Seine	92–99
Winter Cruises: Rhine and Danube	100–117
The AMADEUS Fleet	118–131
Shore Excursions	132–147
General Terms and Conditions of Travel	148–149
Important Information	150
2024 Cruise Planner	151



EFFORTLESS TRAVEL THE AMADEUS WAY

A Passion for Luxury

Embark on a journey with the AMADEUS fleet – enjoy the convenience of only having to unpack your suitcase once then sit back as your floating hotel cruises to a new destination every day. Whether you want to get to know new countries and cultures, explore spectacular natural landscapes or simply enjoy pure relaxation: There are a thousand good reasons to travel, but one passion that we share: That is the luxury of an AMADEUS river cruise.

RIVER PIONEER

As family-run company with over 40 years of river cruising experience, AMADEUS River Cruises was built upon a foundation of long-standing traditions, forward thinking innovation and impeccable hospitality.

OUR TRADITION

Our commitment to maintain our role as leaders in luxury European River Cruising is stronger than ever. With every new ship we celebrate the evolution of our fleet as we continue our tradition of innovation and excellence.

OUR INNOVATION

They say the possibilities are limited on the river. However, our AMADEUS vessels prove the contrary and that creativity, design standards and technical innovations know no limits. We utilize the latest state-of-the-art systems and onboard technology to maintain and sustain the rivers and environments around us.

OUR TRADEMARK

Our philosophy is to combine what we learn over our decades of experience with the constant goal to give passengers on our AMADEUS ships precious travel memories that last a lifetime.





MAXIMUM COMFORT

Experience the Gems of Europe from the Comfort of Your Floating Hotel

Every voyage is an unforgettable experience with AMADEUS, and getting to your destination is an exhilarating part of the journey. The sumptuous comfort on board our ships is heightened by the design and elegant style of our staterooms, which are among the largest on European river cruise ships. Spend restful nights in high-quality beds, feel the closeness of the river through lowerable panorama windows, relax in comfortable armchairs and let your wanderlust roam free.

RELAXED LUXURY

Welcome to a world of European elegance and relaxed sophistication. Every inch of space is perfectly utilized and provides our guests maximum functionality in a stylish setting.

or deck level, light-filled living spaces artfully combined with contemporary décor make your stateroom a sanctuary from the hustle and bustle of everyday life.

SWEET DREAMS

The ambiance of your luxurious stateroom invites you to relax in the morning before your discovery tours and unwind in style at the end of a full day's activities. Regardless of category

ATTENTION TO DETAIL

It's all the little details that make a big difference on board the AMADEUS fleet, from the spacious bathroom with a fully glazed shower and Rituals® care products, to the walk-in closet, to the evening turndown service and much more.



CULINARY EXCELLENCE

A Feast for the Senses

Revel in the stylish ambience of the elegant Panorama-Restaurant, breathtaking views of the shore's landscape, and the high-level service of our staff while savoring our take on haute cuisine. Our exclusive menus reflect the traditions and cultures of regional cuisine and, at the same time, are diverse enough to satisfy an international appetite.

HANDMADE WITH THE BEST INGREDIENTS

Local traditions are a staple in the onboard bakery and patisserie, where fresh bread is baked every day. The finest pastries and desserts are also handmade daily using only the finest local ingredients.

SAVOUR OUR EUROPEAN HERITAGE

It is our pleasure to share our passion for culinary excellence and regional specialties reflected in the sophisticated menu. With an eye for the most minute details, our chefs create incredible meals inspired by the regions we cruise through to tempt you with the flavors of Europe.

OUR FINE WINES

Your AMADEUS wine expert selects fine wines from regional winegrowers and finds the perfect match to complement each dish. Stunning red and whites are mindfully paired with each dinner, and an à la carte collection is stored on board for your own choice.

TO YOUR TASTE

Every day, you can choose between timeless gourmet classics, modern culinary creations and vegetarian alternatives. You can have a 5-course dinner in the Panorama Restaurant or eat light in the Bar. We invite you to take a seat and let yourself be pampered.





Koblenz: Cable car to the fortress Ehrenbreitstein

CUSTOMIZE YOUR TRAVEL EXPERIENCE

A Cultural Treasure Trove is Just Around the River Bend

Every cruise with AMADEUS is designed so that you can experience the “best of” the countries and regions you visit, with the longest possible layovers in your itinerary’s ports. Our excursion programs allow you to decide for yourself how intimately you’d like to know a destination. Follow your heart and indulge your curiosity by finding out what’s over the horizon or around the next bend in the river.

TRAVEL YOUR WAY

You can choose to book individual excursions on board or, more conveniently, you can book discounted excursion packages in advance. Should you wish to make a last-minute excursion reservation on board, our cruise directors are always happy to assist. In addition, enjoy exclusive on-site tastings, engrossing onboard lectures and local tips.

SOMETHING FOR EVERYONE

We take different interests and fitness levels into account when planning our shore excursion programs. Let experienced, local guides share their inside knowledge of the country and its people with you as you explore Europe’s finest and most charming destinations.

GO ADVENTURING

The free onboard bike rental program allows you to set your own pace and track down many secret gems away from the beaten path. E-bikes are also available on the Rhine, Main and Danube Rivers, so that you can enjoy the destinations from a unique perspective, regardless of age or fitness level.

RECHARGE

The spacious Sun Deck, the Panorama Bar, the River Terrace open-air lounge and the cozy and intimate AMADEUS Club are all waiting for you to relax and recharge in your favorite location.

Image, left side: The Church St.-George in Oplenac, Serbia

Our Commitment to Being Green

For over 40 years, we have been cruising the most beautiful regions along European rivers and, from the very beginning, our special way of traveling has been rooted in a great respect for nature, culture and the people we meet along the way. From the launch of the first AMADEUS ship, we not only met environmental protection standards but also set new ones. This has remained the case to this day and, as a family business, sustainability is more than just a buzzword for us—it is fundamental to our core values.

REDUCED CARBON EMISSIONS

The new generation of AMADEUS ships have innovative engines that effectively reduce overall fuel consumption. Our Fleet Controlling System allows our engines to run as efficiently as possible and ensures that our ships travel at the speed that consumes the least fuel.

ENERGY-EFFICIENT TECHNOLOGY

When we are in port, we connect our ships to the on-site energy grid via Powerlock whenever possible. This allows us to reduce noise and dirt in the surrounding cities. This also applies to the winter period, when we prepare our fleet for the new season. On board, we utilize the newest generation of energy-efficient technology to lower power consumption across the board.

ECO-FRIENDLY WATER TREATMENT

Naturally, we have a special connection with water—that's why it's so important to us to keep it clean. Using membrane technology, our filtration plants use microfiltration systems and recycle all

the water we use on board. In addition, we make sure to use as little water as possible. For example, we use vacuum toilets to minimize water consumption. We also encourage passengers to reuse towels as often as possible.

LESS PLASTIC, MORE RECYCLING

We don't believe in single-use plastic. You'll find soap and shampoo dispensers in every bathroom and glass water bottles on every cabin table. In the near future, we will also introduce Tetra Pak water containers for every excursion.

With our modern waste management system, we ensure that much of what we dispose of becomes valuable raw material, ready to be repurposed.

ENVIRONMENTAL CERTIFICATION

The AMADEUS fleet is certified with the prestigious *Green Award* – a recognition of our industry-leading performance in safety and environmental standards.



THE AMADEUS NOVA: NEW STANDARDS IN SUSTAINABILITY

Our newest ship underscores our commitment to a green future for river cruising. The *AMADEUS Nova* has a hybrid diesel-electric drive and a powerful battery that covers engine power peaks. The sophisticated, cutting-edge technology of the engines not only reduces emissions significantly but also almost completely eliminates air pollutants thanks to specially developed filters and catalytic converters. Solar panels feed electrical energy into the ship's power circuit. In addition, it features our tried-and-tested, future-oriented Fleet Controlling System and a powerful heat recovery system. At the same time, we have also redefined comfort on board, offering more space, luxury and modern design.



© Jan Wehner/Shutterstock.com

An Overview of AMADEUS Services

From check-in to our Gala Farewell Dinner, we make every effort to provide you with an unparalleled cruise experience. As we invite you to “discover the art of travel your way,” we look forward to welcoming you onboard one of our award-winning vessels and to our many inclusions on board:



LUXURY ACCOMMODATION

Enjoy spacious Mozart Suites with a walk-out balcony, stateroom cabins with drop-down Panorama Retractable Windows, walk-in closet and a luxurious bathroom with a full glass-door shower, make-up mirror, hairdryer, and Rituals® bath products.*



HIGHEST QUALITY OF SERVICE

Our highly trained staff and crew members are there to ensure your happiness around the clock. From the captain and the cruise director to your stateroom and bar personnel, we offer exquisite service that is both professional and courteous.



GOURMET CUISINE

Our exclusive, regionally influenced menus with the freshest ingredients take you on culinary journeys of discovery – accompanied by hand-selected wines. You always have the choice between sophisticated, timeless classics, and vegetarian alternatives.



ENTERTAINMENT ON BOARD

Depending on the cruise you choose, you will enjoy a variety of enriching onboard programs, including fascinating lectures, cooking demonstrations, local cultural performances, and music by our onboard musicians.



COFFEE & TEA STATION

In addition to the coffee or tea we serve you after every lunch and dinner, you can help yourself to our coffee and tea station, available 24-hours a day in the AMADEUS Club.



ONBOARD FITNESS CENTER

Every AMADEUS vessel features a state-of-the-art fitness center open 24-hours a day – and complete with the latest cardio and training equipment – for those not looking to give their abs, biceps or triceps a vacation.

CRUISE DIRECTOR

Our experienced cruise managers are happy to assist by planning your adventure with suggestions of things to do during your cruise and how to get there. Should you wish to make a last-minute excursion reservation on board, our cruise directors are ready to help.



Wi-Fi ON BOARD

Stay in touch with friends and family: On board the AMADEUS vessels Wi-Fi is available and can be used for a small fee. Stay connected and share your experiences throughout your journey.



WINES

Each dinner on board is enhanced by the thoughtful pairing of red and white wines. Should you prefer to make your own selection, we maintain an onboard à la carte collection of wines to cater to individual tastes.



ONBOARD BICYCLES

If you want to venture out on your own, you are welcome to borrow a complimentary bicycle for the day. E-bikes are available on Rhine, Main and Danube Cruises.



AMADEUS AUDIO SYSTEM

The AMADEUS digital audio-system is included for all guided excursions and supports you in a relaxed and uncomplicated way during your discovery tours.

Inclusions on Board

- Luxury accommodation in an outside river-view stateroom of your choice, most with French balcony* and with a walk-out balcony in the Suites*
- Gourmet dining featuring breakfast, multi-course lunches and dinners with menu choices (incl. vegetarian options), afternoon tea and late-night snack
- Coffee and tea served after every lunch and dinner
- 24-hour self-service hot beverage station with complimentary coffee and tea
- Welcome and Farewell Cocktail Reception, Welcome Dinner and Captain's Gala Dinner
- Variety of enriching onboard programs, including fascinating lectures, cooking demonstrations, local cultural performances, and music by our onboard musicians
- Personalized service of an experienced, multilingual AMADEUS Cruise Director
- AMADEUS digital audio system for all guided excursions
- Complimentary use of onboard bicycles for independent exploration
- Fitness room open around the clock with modern equipment
- Onboard language German and English
- All port taxes, embarkation, disembarkation and lock fees included in your cruise faire

Optional Services

- **Excursions and excursion packages:** For every cruise we offer 3 to 4 different excursion packages, which you can book in advance at a reduced price. Alternatively, all excursions can also be booked individually on board at regular prices.
- **Transfer and Parking:** Please refer to the pricing page of each cruise for further information.
- Onboard laundry service (wash, iron, press)
- Massage room
- Onboard gift shop
- Onboard Wi-Fi

*Please see ship information (pages 122–131) for stateroom and suite details on the AMADEUS Brilliant and the AMADEUS Diamond.



AMADEUS CRUISER CLUB

Become a member of the AMADEUS family

Hundreds of destinations, thousands of river kilometers and endless possibilities: if you've really acquired a taste for cruising with us and still haven't had enough of relaxed deluxe river travel, you're in good hands in our AMADEUS Cruiser Club. Because those who travel with us are rewarded for their loyalty with a wide range of benefits – starting with the second cruise.

Membership in the club costs you nothing, except a few minutes of your time to fill out the registration form. You can find this and current information at www.lueftner-cruises.com/club.



Your AMADEUS CLUB advantage at a glance

Levels	Welcome-Bonus*	Annual Bonus**	Invitation to the exclusive ACC-Cocktail	Free cabin upgrade to the next category***	Invitation to the Captain's Table during the Captain's Gala Dinner	Free spa treatment (1 hour)	Invitation to exclusive AMADEUS events
AMADEUS CRUISER CLUB: after 1st cruise							
Cruise 2	€ 30,-	€ 30,-	•				
Cruise 3		€ 30,-	•				
AMADEUS CRUISER CLUB-STAR-Status: after 3rd cruises							
Cruise 4	€ 50,-	€ 50,-	•	•	•		
Cruise 5		€ 50,-	•	•	•		
Cruise 6		€ 50,-	•	•	•		
Cruise 7		€ 50,-	•	•	•		
AMADEUS CRUISER CLUB-GOLD-Status: after 7th cruise							
Cruise 8	€ 100,-	€ 100,-	•	•	•	•	•
Cruise 9 and more		€ 100,-	•	•	•	•	•

* Welcome Bonus: can only be used as credit on board; valid for 5 years from date of issue
 ** Annual bonus: can only be used as credit on board; valid for 1 year from date of issue
 *** Subject to availability at commencement of journey



Rhine, Main, Moselle, Saar, the Dutch and Belgian Waterways

Tulip Serenade 22 – 25

8 days Amsterdam – Ghent – Amsterdam

Classical Rhine 26 – 31

8 days Basel – Amsterdam or Amsterdam – Basel

Three-Rivers Cruise 32 – 35

8 days Amsterdam – Nuremberg

Saar & Moselle Fairytale 36 – 39

8 days Cologne – Saarlouis – Cologne

Rhine & Danube Symphony 40 – 45

8 days Cologne – Passau or Passau – Cologne

German Riverscapes 46 – 51

9 days Trier – Passau or Passau – Trier

Across Europe 52 – 55

15 days Amsterdam – Budapest

Tulip Serenade

8 days | Amsterdam – Ghent – Amsterdam

15%
Early Booking
Discount



Enjoy spring as the countryside awakens from a long winter's slumber. Cruise along the Waterways of Holland & Belgium, past lazily spinning windmills, blossoming foliage and sleepy towns. Along the intricate net of extensive waterways, explore the capital city of Amsterdam, 'the Venice of the North', the quaint villages and Renaissance cities of Ghent, Antwerp and Bruges medieval churches. View Dutch and Flemish masterpieces and taste Dutch cheeses and world-famous Belgian chocolates. Take the opportunity to visit the Keukenhof gardens with its 79 acres of breathtaking beauty, only open in the spring. A riot of flowers exploding in color and scent as well as centuries of history and culture make the Tulip Serenade a wonderful treat.

Unmissable landmarks of Holland: windmills and colorful tulips

Your itinerary

DAY/PORT	ARR	DEP	HIGHLIGHTS OF THE PROGRAM
1 Amsterdam		22:00	Embarkation from 4 pm Welcome Cocktail and Welcome Dinner Shanty Choir on board
2 Arnhem	08:00	18:30	<ul style="list-style-type: none"> • Arnhem and the history of World War II • Arnhem and the Open Air Museum or Visit to the Kröller-Müller-Museum
3 Middelburg	11:00	18:00	<ul style="list-style-type: none"> • Delta Works experience & Veere walking tour or Middelburg walking tour
4 Ghent	02:00	19:30	<ul style="list-style-type: none"> • Ghent with Gravensteen medieval fortress • Bruges – Venice of the North
5 Antwerp	05:00	20:00	<ul style="list-style-type: none"> • Brussels with Atomium & Cinquantenaire park • Antwerp and the Cathedral of Our Lady
6 Rotterdam	06:00	20:00	<ul style="list-style-type: none"> • Kinderdijk and visit to the windmills • Visit to the Keukenhof Flower Gardens
7 Amsterdam	05:00		<ul style="list-style-type: none"> • Amsterdam & iconic canal cruise • A Dutch Trip to Waterland Captain's Gala Dinner
8 Amsterdam			Disembarkation after breakfast

Excursions listed in blue are not included in the cruise price.

Please refer to pages 132 – 147 for specific shore excursion details.

We reserve the right to make amendments to the timetable and program.

Price per person in double cabin from **1.379,-**€





Amsterdam canal scenery with bridges, boats, bikes and flowerbeds

Your day program Cruise Amsterdam – Ghent – Amsterdam

DAY 1 | NETHERLANDS: AMSTERDAM

Your Dutch adventure begins in Amsterdam, where you will embark in the afternoon. After a Welcome Cocktail and a celebratory Welcome Dinner, you will get to enjoy a performance on board by a traditional shanty choir, setting the mood for the days to come.

DAY 2 | ARNHEM

Voted “greenest city in Europe”, Arnhem rebuilt itself after the famed 1944 battle immortalized in the film “A Bridge Too Far”, and is now a thriving artists’ town with fine museums and beautiful parks. Choose to join the morning city tour to appreciate its beautiful sights and delve deeper into the history of World War II at the War Museum. Later in the day, choose between a trip to the Open Air Museum with views of charming Dutch buildings, industries and crafts of bygone times and the Kröller-Müller-Museum, housing the second-largest collection of Van Gogh paintings in the world. Relax on board in the evening, enjoying a delicious dinner as your vessel cruises onwards to Middelburg.

DAY 3 | MIDDELBURG

Before lunchtime, your cruise ship will dock in Middelburg. As one of the centers where the Dutch East India Company flourished in the 17th century, this lovely city features historic merchant houses and storefronts lining its canals. This afternoon, take part in a guided walking tour and learn more about its history and culture, or visit Netherlands’ “morn wonder of the world,” the Delta Works, which protect the southwest of the country from the sea. Continue to the historic village of Veere.

DAY 4 | BELGIUM: GHENT

During the night, your vessel will dock in Ghent, the ultimate medieval city, which you can explore in the morning. Admire architecture preserved since the late Middle Ages and visit 13th century residence of the Counts of Flanders, the Gravensteen or “Castle of the Counts”.

In the afternoon, join the excursion to Bruges, the capital of the province of West Flanders. With its cobbled streets, crooked bridges, meandering canals and World Heritage-listed medieval buildings, the Belgian city of Bruges is bursting with fantastic 12% brews, boutique chocolate-makers and canal-side bars. There’s also the Basilica of the Holy

Blood, a double-decker chapel which has a Romanesque church down below and a neo-Gothic church up above.

DAY 5 | ANTWERP

Antwerp, the second-largest city in Belgium, welcomes you today. After breakfast, join the excursion to the politically and culturally significant city of Brussels. View the iconic Atomium, which was created for the 1958 Brussels World’s Fair and, thanks to its popularity, was not torn down as originally planned. Visit the Cinquantenaire Park with its triumphal arch, built to celebrate the 50th anniversary of Belgium’s independence.

In the afternoon, explore Antwerp in a comfortable coach. Famous for its diamond trade, the city also boasts many cultural highlights such as the Cathedral of Our Lady with pain-

One of the largest water castles in Europe: Gravensteen Castle in the historic center of Ghent



“There is so much to take in and see at the Keukenhof Gardens, we could have easily spent two days there.”

Benjamin D.

tings by the famous Baroque artist Peter Paul Rubens. In the evening, enjoy dinner, while your vessel returns to the Netherlands.

DAY 6 | NETHERLANDS: ROTTERDAM

Early morning, your ship will arrive in Rotterdam, the second largest city in the Netherlands. After breakfast, you can pay a visit to Kinderdijk, which houses the most unique windmill complex in the world. Built to drain water from the soil, these windmills are now protected by UNESCO and are one of the Netherlands’ most popular tourist destinations. After lunch, you can explore the world-famous Keukenhof gardens.

During dinner, the ship departs for the final leg of the cruise back to Amsterdam.

DAY 7 | AMSTERDAM

Amsterdam welcomes you back today with its enchanting blend of old-world charm and contemporary allure.

In the morning, cruise through the lovely, verdant canals of Amsterdam while learning more about the city’s history and significance. After lunch, you can visit Waterland in North Holland, where you will stop in the charming fishing village of Volendam and the equally picturesque town of Edam. Renowned for its cheeses, this is the perfect spot for a cheese tasting (included in the excursion). This evening, the festive Captain’s Gala Dinner will provide a fitting finish to the day.

DAY 8 | AMSTERDAM

Enjoy one more leisurely breakfast on board before disembarking. The AMADEUS team wishes you a safe journey home and looks forward to seeing you again in future.

Keukenhof



Cruise fares per person in EUR based on double occupancy of a cabin

TOUR DATE	VESSEL	CABIN TYPE & DECKS					
		C-4 Haydn	C-1 Haydn	B-4 Strauss	B-1 Strauss	A-1 Mozart	Suite Mozart
8 days Amsterdam – Ghent – Amsterdam							
30.03. – 06.04.	AMADEUS Cara	1.379	1.599	1.869	2.029	2.239	2.639
06.04. – 13.04.	AMADEUS Cara	1.459	1.689	1.969	2.139	2.349	2.779
16.04. – 23.04.	AMADEUS Imperial	1.599	1.859	2.159	2.349	2.589	3.059
21.04. – 28.04.	AMADEUS Queen	1.759	2.039	2.379	2.589	2.849	3.359
28.04. – 05.05.	AMADEUS Queen	1.759	2.039	2.379	2.589	2.849	3.359
02.05. – 09.05.	AMADEUS Riva	1.759	2.039	2.379	2.589	2.849	3.359

Early booking discount of 15% on the above-mentioned prices when booked by Nov 30, 2023.

Single cabin supplement per person for all dates:

C-4 + C-1: 15%, B-4: 30%, B-1: 50%, A-1: 60%, Suite: 100% of cruise price.

For cruise price inclusions, see page 16, for deck plans see page 118–131.

Excursion packages prices per person in EUR and if booked in advance

Cruise Amsterdam – Ghent – Amsterdam	UP	A	B	C
Arnhem and the history of World War II	76	●	●	●
Arnhem and the Open Air Museum	76		●	
or Visit to the Kröller-Müller-Museum	93			●
Delta Works experience & Veere walking tour	113		●	●
or Middelburg walking tour	25	●		
Ghent with Gravensteen medieval fortress	59	●	●	●
Bruges – Venice of the North	52			●
Brussels with Atomium & Cinquantenaire park	52	●	●	●
Antwerp and the Cathedral of Our Lady	55			●
Kinderdijk and visit to the windmills	88	●	●	●
Visit to the Keukenhof Flower Gardens	94		●	●
Amsterdam & iconic canal cruise	68	●	●	●
A Dutch Trip to Waterland	57			●
Excursion packages with 15% discount*		313	532	686

*compared to the unit price (UP) on board.

Package A with 6 excursions, Package B with 8 excursions and Package C with 11 excursions. Please refer to pages 132 – 147 for specific shore excursion details.

Transfers prices per person in EUR

Amsterdam: train station – vessel or v.v.	50
Amsterdam: airport – vessel or v.v.	59

Classical Rhine

8 days | Basel – Amsterdam or Amsterdam – Basel
 With „Rhine in Flames®“ tour date Aug 7, 2024

15%
 Early Booking
 Discount



Discover the many beautiful facets of “Father Rhine” along 500 miles of rivers from Amsterdam in the Netherlands through Germany and France to Basel, Switzerland or vice versa. Pass through the Dutch IJsselmeer on the way to the cathedral city of Cologne. Take a detour along the winding Moselle River its blossoming vineyards tucked on each side of the valley. Delight in the panorama of the myth-enshrouded Middle Rhine Valley with its high concentration of castles nestled on sunny hillsides around every bend, and the fabled Lorelei – mythical siren of the Rhine. Visit quintessential wine villages as well as one of Germany’s oldest cities – Speyer. Visit Strasbourg, the capital city of the Grand Est region (formerly Alsace) before ending in Basel, located at the three countries corner of France, Germany and Switzerland.

Rheinstein Castle near Trechtingshausen in the Upper Middle Rhine Valley

Your itinerary

BASEL – AMSTERDAM

DAY/PORT	ARR	DEP	HIGHLIGHTS OF THE PROGRAM
1 Basel		17:00	Embarkation from 4 pm Welcome Cocktail and Welcome Dinner
2 Strasbourg	09:00	23:00	• Strasbourg with canal boat tour • Romantic Alsace and its wines
3 Speyer Mannheim	07:00 14:00	12:00 23:59	• Speyer walking tour & the Imperial Cathedral • Romantic Heidelberg with castle ruins
4 Rüdesheim	07:00	12:00	• Rüdesheim with Music Cabinet Museum or Rüdesheim wine tasting & Drosselgasse Cruise through the Upper Middle Rhine Valley • Koblenz walking tour and Ehrenbreitstein Fortress
Koblenz		15:30	
5 Koblenz Cochem		06:00 13:30	06:00 18:00 Scenic cruising on the Moselle River • Cochem walking tour & Reichsburg Castle
6 Cologne	07:00	13:00	• Cologne walking tour and Kölsch tasting
7 Amsterdam	08:00		• Amsterdam & iconic canal cruise • Haarlem – art, history and Dutch lifestyle or A Dutch Trip to Waterland Captain’s Gala Dinner Shanty Choir on board
8 Amsterdam			Disembarkation after breakfast

Excursions listed in blue are not included in the cruise price.
 Please refer to pages 132 – 147 for specific shore excursion details.
 We reserve the right to make amendments to the timetable and program.
 For the Amsterdam – Basel and „Rhine in Flames®“ itineraries, see pages 30 – 31.

Price per person in double cabin from **1.539,-**€





AMADEUS ship in front of Cologne Rhine front with Hohenzollern bridge and famous cathedral

Your day program Cruise Basel – Amsterdam

DAY 1 | SWITZERLAND: BASEL

Your journey begins in Basel, the third largest city in Switzerland. Embark your AMADEUS vessel and join fellow travelers at a Welcome Cocktail followed by a Welcome Dinner. Your floating hotel departs late this afternoon.

DAY 2 | FRANCE: STRASBOURG

During the night, your ship left Switzerland and followed the Rhine into the Alsace region of France to Strasbourg, a city known not only for its romantic old town, but also for the numerous important European institutions. In the morning, explore the city independently, or as part of an organized tour. In the afternoon, a detour to the countryside is highly recommended, particularly along the famous wine route, where the quaint wine-growing villages will delight wine-lovers and the general public alike. Late tonight, your ship departs for Germany.

DAY 3 | GERMANY: SPEYER · MANNHEIM

Before breakfast, arrive in Speyer, which played a central role in the Holy Roman Empire during the Middle Ages. Your ship remains here until lunchtime, offering time to explore this historic destination on your own or with the guided tour. During lunch, your cruise will continue towards Mannheim, our next stop along the picturesque Rhine where it will dock for the remainder of the day. Take the excursion to the nearby city of Heidelberg, which boasts a beautiful Baroque old town. Late at night, your vessel continues to Rudesheim, a wine-making town.

DAY 4 | RÜDESHEIM · KOBLENZ

Two charming stops await you today. In the morning, arrive in Rudesheim, a town well known for its wine-making. Explore the town on a guided tour with a stop to see the private collection of automated musical instruments at the Mechanical Music Cabinet Museum. Or choose to go farther afield to a local vineyard for a tasting of the wines of the area, finishing with a walk along the lively "Drosselgasse". The ship will depart punctually at lunchtime to cruise the most picturesque section of the river – the Upper Middle Rhine Valley. The view from the Sun Deck of the myth-en-

"An unforgettable moment: We stood on the sun deck with a glass of Riesling wine and passed the Loreley rock"

Simone F.

shrouded Lorelei Rock is sure to be a highlight. After lunch, arrive in Koblenz, one of Germany's oldest towns, where you can end the day with a stroll through the pedestrian area and the cable car to Ehrenbreitstein Fortress, located high above the hill.

DAY 5 | KOBLENZ · COCHEM

The vessel departs from Koblenz in the early hours, and makes a detour along the Moselle

Strasbourg's historic old town district "La Petite France"



River to the most romantic part of the valley and the little town of Cochem. The magnificent Reichsburg castle which overlooks the town, dominates the landscape. Down below, the town, with its narrow streets, half-timbered houses, and numerous restaurants, is an ideal setting to taste the wines of the region. Back on board, dinner is served as the journey continues to Cologne.

DAY 6 | COLOGNE

The morning is dedicated to the fascinating cathedral city of Cologne, which has over a million inhabitants. You can expect a young, vibrant metropolis with a rich cultural history and world-famous sights, in particular the Cologne Cathedral. Enjoy a walking tour of the gothic old town as well as a tasting of the local Kölsch beer. After lunch, your vessel departs from Cologne for an afternoon of cruising.

DAY 7 | NETHERLANDS: AMSTERDAM

By breakfast you will have crossed yet another country border to arrive in the Dutch city of Amsterdam, the capital of the Netherlands. There are many things to do in this vibrant canal city. After breakfast choose to explore the city by canal boat.

This afternoon offers the opportunity to join the excursion through the Waterland to the pretty villages of Volendam and the equally picturesque town Edam and a tasting of delicious Dutch cheese. Or perhaps venture out to the town of Haarlem with its medieval character and gothic Cathedral, just a short drive away. This evening, the Captain invites you to a festive Gala Dinner. After dinner, enjoy a rousing Shanty Choir performance to end the evening. The vessel remains in Amsterdam overnight.

DAY 8 | AMSTERDAM

After breakfast, we bid you farewell and wish you a safe journey home.

On excursion at the IJsselmeer



Cruise fares per person in EUR based on double occupancy of a cabin

TOUR DATE	VESSEL	CABIN TYPE & DECKS					
		C-4 Haydn	C-1 Haydn	B-4 Strauss	B-1 Strauss	A-1 Mozart	Suite Mozart
8 days Basel – Amsterdam							
09.04. – 16.04.	AMADEUS Imperial	1.539	1.789	2.079	2.259	2.509	2.929
12.05. – 19.05.	AMADEUS Queen	2.069	2.399	2.799	3.039	3.379	3.939
25.05. – 01.06.	AMADEUS Cara	2.179	2.529	2.949	3.199	3.559	4.149
26.05. – 02.06.	AMADEUS Queen	2.179	2.529	2.949	3.199	3.559	4.149
09.06. – 16.06.	AMADEUS Queen	2.179	2.529	2.949	3.199	3.559	4.149
06.07. – 13.07.	AMADEUS Cara	2.179	2.529	2.949	3.199	3.559	4.149
17.07. – 24.07.	AMADEUS Queen	2.069	2.399	2.799	3.039	3.379	3.939
22.07. – 29.07.	AMADEUS Star	2.069	2.399	2.799	3.039	3.379	3.939
28.08. – 04.09.	AMADEUS Queen	2.179	2.529	2.949	3.199	3.559	4.149
11.09. – 18.09.	AMADEUS Queen	2.179	2.529	2.949	3.199	3.559	4.149
28.09. – 05.10.	AMADEUS Star	2.179	2.529	2.949	3.199	3.559	4.149
12.10. – 19.10.	AMADEUS Star	2.069	2.399	2.799	3.039	3.379	3.939
26.10. – 02.11.	AMADEUS Star	1.909	2.219	2.579	2.799	3.079	3.629

Early booking discount of 15% on the above-mentioned prices when booked by Nov 30, 2023.

This cruise departure is also bookable as golf cruise, page 94.

Single cabin supplement per person for all dates:

C-4+C-1: 15%, B-4: 30%, B-1: 50%, A-1: 60%, Suite: 100% of cruise price.

For cruise price inclusions, see page 16, for deck plans see page 118–131.

Excursion packages prices per person in EUR and if booked in advance

Cruise Basel – Amsterdam	UP	A	B	C
Strasbourg with canal boat tour	76	●	●	●
Romantic Alsace and its wines	78			●
Speyer walking tour & the Imperial Cathedral	29		●	●
Romantic Heidelberg with castle ruins	64	●	●	●
Rudesheim with Music Cabinet Museum or Rudesheim wine tasting & Drosselgasse	33 50		●	●
Koblenz walking tour and Ehrenbreitstein Fortress	52	●	●	●
Cochem walking tour & Reichsburg Castle	45	●	●	●
Cologne walking tour and Kölsch tasting	44	●	●	●
Amsterdam & iconic canal cruise	68	●	●	●
Haarlem – art, history and Dutch lifestyle or A Dutch Trip to Waterland	46 57		●	●
Excursion packages with 15% discount*		297	388	479

*compared to the unit price (UP) on board.

Package A with 6 excursions, Package B with 9 excursions and Package C with 10 excursions. Please refer to pages 132 – 147 for specific shore excursion details.

Transfers prices per person in EUR

Basel: train station – vessel or v.v.	65
Basel: airport – vessel or v.v.	65
Amsterdam: vessel – train station or v.v.	50
Amsterdam: vessel – airport or v.v.	59

Your itinerary

AMSTERDAM – BASEL

DAY/PORT	ARR	DEP	HIGHLIGHTS OF THE PROGRAM
1 Amsterdam			Embarkation from 4 pm Welcome Cocktail and Welcome Dinner Shanty Choir on board
2 Amsterdam	08:30		• Amsterdam & iconic canal cruise or A Dutch Trip to Waterland
Utrecht	12:30	13:00	Rejoin the ship
3 Cologne	10:30	20:30	• Cologne walking tour and Kölsch tasting • Siebengebirge and Drachenfels castle ruins
4 Cochem	14:00	21:45	Scenic cruising on the Moselle River • Cochem walking tour & Reichsburg Castle • Tasting of typical Moselle wines in a local winery
5 Koblenz	06:00	11:00	• Koblenz walking tour
Rüdesheim	17:00	22:00	Cruise through the Upper Middle Rhine Valley • Rüdesheim with Music Cabinet Museum or Rüdesheim wine tasting & Drosselgasse
6 Mannheim	06:00	13:00	• Romantic Heidelberg with castle ruins
Speyer	15:30	19:30	• Speyer walking tour & the Imperial Cathedral
7 Strasbourg	07:30	13:00	• Strasbourg with canal boat tour Captain's Gala Dinner
8 Basel	09:00		Disembarkation after breakfast

Excursions listed in blue are not included in the cruise price.
Please refer to pages 132 – 147 for specific shore excursion details.
We reserve the right to make amendments to the timetable and program.



Pure romance: Heidelberg

Fireworks over the Ehrenbreitstein Fortress



Your itinerary

RHINE IN FLAMES®

DAY/PORT	ARR	DEP	HIGHLIGHTS OF THE PROGRAM
1 Amsterdam			Embarkation from 4 pm Welcome Cocktail and Welcome Dinner Shanty Choir on board
2 Amsterdam	08:30		• Amsterdam & iconic canal cruise or A Dutch Trip to Waterland
Utrecht	12:30	13:00	Rejoin the ship
3 Cologne	10:30	20:30	• Cologne walking tour and Kölsch tasting • Siebengebirge and Drachenfels castle ruins
4 Koblenz	06:30	17:30	• Koblenz walking tour • Ehrenbreitstein Fortress in Koblenz Rhine in Flames® – enjoy spectacular fireworks from the sun deck
5 Koblenz	00:30	06:00	Cruise through the Upper Middle Rhine Valley
Rüdesheim	12:30	22:00	• Rüdesheim with Music Cabinet Museum or Rüdesheim wine tasting & Drosselgasse
6 Mannheim	06:00	13:00	• Romantic Heidelberg with castle ruins
Speyer	15:30	19:00	• Speyer walking tour & the Imperial Cathedral
7 Strasbourg	07:30	13:00	• Strasbourg with canal boat tour or Freiburg – Capital of the Black Forest Captain's Gala Dinner
8 Basel	09:00		Disembarkation after breakfast

Excursions listed in blue are not included in the cruise price.
We reserve the right to make amendments to the timetable and program.

Rhine in Flames®

Discover the many beautiful facets of “Father Rhine” during this week-long cruise along one of the most important and attractive rivers of Europe. Take a detour along the winding Moselle River. Delight in the panorama of the myth-enshrouded Middle Rhine Valley with its winelands, the prominent Lorelei rock and the highest density of castles in the world.

The highlight of this trip is a stunning pyrotechnic display featuring colorful fountains, Catherine wheels and crackling comets. Enjoy the spectacle of the romantic Rhine valley bathed in the glow of 800 red lights and magnificent hilltop firework displays. The opening fireworks accompany the start of the boat parade, which provides some 22,000 passengers with mesmerizing views of the illuminated castles, palaces and river-side promenades.

Cruise fares

per person in EUR based on double occupancy of a cabin

TOUR DATE	VESSEL	CABIN TYPE & DECKS					
8 days Amsterdam – Basel		C-4 Haydn	C-1 Haydn	B-4 Strauss	B-1 Strauss	A-1 Mozart	Suite Mozart
02.04. – 09.04.	AMADEUS Imperial	1.539	1.789	2.079	2.259	2.509	2.929
04.05. – 11.05.	AMADEUS Cara	2.069	2.399	2.799	3.039	3.379	3.939
19.05. – 26.05.	AMADEUS Queen	2.179	2.529	2.949	3.199	3.559	4.149
16.06. – 23.06.	AMADEUS Queen	2.179	2.529	2.949	3.199	3.559	4.149
29.06. – 06.07.	AMADEUS Cara	2.179	2.529	2.949	3.199	3.559	4.149
13.07. – 20.07.	AMADEUS Cara	2.179	2.529	2.949	3.199	3.559	4.149
15.07. – 22.07.	AMADEUS Star	2.069	2.399	2.799	3.039	3.379	3.939
21.09. – 28.09.	AMADEUS Star	2.179	2.529	2.949	3.199	3.559	4.149
05.10. – 12.10.	AMADEUS Star	2.179	2.529	2.949	3.199	3.559	4.149
19.10. – 26.10.	AMADEUS Star	1.999	2.329	2.719	2.949	3.279	3.819
8 days “Rhine in Flames®”		C-4 Haydn	C-1 Haydn	B-4 Strauss	B-1 Strauss	A-1 Mozart	Suite Mozart
07.08. – 14.08.	AMADEUS Queen	2.069	2.399	2.799	3.039	3.379	3.939

Early booking discount of 15% on the above-mentioned prices when booked by Nov 30, 2023.

Single cabin supplement per person for all dates:
C-4 + C-1: 15%, B-4: 30%, B-1: 50%, A-1: 60%, Suite: 100% of cruise price.
For cruise price inclusions, see page 16, for deck plans see page 118–131.

Excursion packages

prices per person in EUR and if booked in advance

Cruises Amsterdam – Basel	UP	A	B	C
Amsterdam & iconic canal cruise or A Dutch Trip to Waterland	68 57	•	•	•
Cologne walking tour and Kölsch tasting	44	•	•	•
Siebengebirge and Drachenfels castle ruins	81		•	•
Cochem walking tour & Reichsburg Castle	45	•	•	•
Tasting of typical Moselle wines in a local winery	18			•
Koblenz walking tour	24	•	•	•
Rüdesheim with Music Cabinet Museum or Rüdesheim wine tasting & Drosselgasse	33 50		•	•
Romantic Heidelberg with castle ruins	64	•	•	•
Speyer walking tour & the Imperial Cathedral	29		•	•
Strasbourg with canal boat tour	76	•	•	•
Excursion packages with 15% discount*		273	385	424

Themed cruise „Rhine in Flames®”	UP	A	B	C
Amsterdam & iconic canal cruise or A Dutch Trip to Waterland	68 57	•	•	•
Cologne walking tour and Kölsch tasting	44	•	•	•
Siebengebirge and Drachenfels castle ruins	81		•	•
Koblenz walking tour	24		•	•
Ehrenbreitstein Fortress in Koblenz	52			•
Rüdesheim with Music Cabinet Museum or Rüdesheim wine tasting & Drosselgasse	33 50	•	•	•
Romantic Heidelberg with castle ruins	64	•	•	•
Speyer walking tour & the Imperial Cathedral	29		•	•
Strasbourg with canal boat tour or Freiburg – Capital of the Black Forest	76 46	•	•	•
Excursion packages with 15% discount*		242	267	400

*compared to the unit price (UP) on board.
– Cruise Amsterdam – Basel:
Package A with 6, Package B with 9 and Package C with 10 excursions,
– Cruise „Rhine in Flames®”:
Package A with 5, Package B with 7 and Package C with 9 excursions.

Please refer to pages 132 – 147 for specific shore excursion details.

Three-Rivers Cruise

8 days | Amsterdam – Nuremberg

15%
Early Booking
Discount

Get ready for an unforgettable European experience which fits the wonders of Dutch waterways, the Rhine, the Main and the Main-Danube Canal, all into one cruise. Highlights of the itinerary are the capital city of Amsterdam with its many canals and bustling streets, the cathedral city of Cologne, the Upper Middle Rhine Valley and its incredible wealth of castles and winegrowing villages, the historic university city of Würzburg and the medieval town of Bamberg in Bavaria. Along the way, pass the Main-Danube canal, an engineering marvel completed in 1992 connecting the rivers through the heart of Europe.

Rothenburg ob der Tauber lies on the "Romantic Road" and delights with its extremely homogeneous, medieval townscape.

Your itinerary

DAY/PORT	ARR	DEP	HIGHLIGHTS OF THE PROGRAM
1 Amsterdam			Embarkation from 4 pm Welcome Cocktail and Welcome Dinner Shanty Choir on board
2 Amsterdam Utrecht	08:30 11:30	12:30	• Amsterdam with canal trip and Holland Waterland Rejoin the ship
3 Cologne	10:00	20:00	• Cologne walking tour and Kölsch tasting • Siebengebirge and Drachenfels castle ruins
4 Rüdesheim	12:00	15:00	Cruise through the Upper Middle Rhine Valley • Rüdesheim with Music Cabinet Museum or Rüdesheim wine tasting & Drosselgasse
5 Miltenberg Wertheim	14:00 18:30	14:30 19:00	• Miltenberg and Wertheim with glass museum Rejoin the ship
6 Würzburg	09:00	13:00	• Würzburg walking tour with Residence and wine tasting or Medieval Rothenburg ob der Tauber
7 Bamberg	13:00	19:00	• Bamberg walking tour Onboard talk about the Main-Danube canal Captain's Gala Dinner
8 Nuremberg	07:30		Disembarkation after breakfast

Excursions listed in blue are not included in the cruise price.

Please refer to pages 132 – 147 for specific shore excursion details.

We reserve the right to make amendments to the timetable and program.

Price per person in double cabin from **1.969,-** €





Amsterdam's city center is crisscrossed by small canals

Your day program Cruise Amsterdam – Nuremberg

DAY 1 | NETHERLANDS: AMSTERDAM

Historic Amsterdam, the famous capital of the Netherlands, is the starting point of your European cruise. After embarkation, enjoy a Welcome Cocktail and savor fabulous dishes at the Welcome Dinner. At the end of the day a rousing performance by a traditional shanty choir completes the experience.

DAY 2 | AMSTERDAM · UTRECHT

In the morning, enjoy a cruise along the famous Amsterdam canals, followed by a trip to the beautiful Waterland region with historic fishing villages and peaceful countryside. Waterland is the 'wet back garden of Amsterdam'. This rural area has a truly ancient Dutch landscape: perfectly flat, with old 'polders', lush green pastures, winding dikes and working windmills. Rejoin your ship in Utrecht for lunch.

DAY 3 | GERMANY: COLOGNE

In the morning, discover the highlights of Cologne on the guided city tour. End with a glass of typical Kölsch, a famed Rhineland beer. After lunch, nature enthusiasts may wish to partake in the excursion to the Sieben-gebirge National Park, Germany's first nature reserve, and Drachenfels castle ruins. With the Rhine sprawling below in all its splendor, the views from the top of the castle ruins are stunning. After an exciting day, return to the vessel to continue south along the river.

"We loved the traditional shanty singers on board in Amsterdam. Such a fun way of learning about the Dutch maritime history."

Nick & Helen A.

DAY 4 | RÜDESHEIM

The morning starts on a high note with the passage of the Lorelei in the mythenshrouded Upper Middle Rhine Valley. At lunchtime, the vessel arrives in Rüdesheim, a picturesque wine-making town in the Rhine Gorge where the river landscape has enchanted visitors for centuries, and is protected by UNESCO since 2002. Discover the region's rich history on a walking tour and admire the magical collection of instruments at the Music Cabinet Museum. Or take, instead, a tram ride through the vineyards of Rüdesheim on the "Wine Express", enjoy some fine wine

of the region and stroll along the famous quaint "Drosselgasse", a 144 m (472 ft) cobbled street lined with timber-framed buildings and many traditional restaurants.

DAY 5 | MILTENBERG · WERTHEIM

After a tranquil morning on board, join the afternoon excursion to Miltenberg and Wertheim. Miltenberg, the „Pearl of the Main River“, is a town flanked by the river Main with an incredible, forested hillside, and features Miltenberg castle and one of the oldest inns in Germany, the Hotel "Zum Riesen". Continue to Wertheim and explore the medieval streets with their half-timbered houses and the unique glass museum, that invites visitors on a tour of the 3,000 year

Half-timbered romanticism in Miltenberg am Main



history of glass. This evening, join your new friends for another memorable meal as the ship plies the waters towards our next stop.

DAY 6 | WÜRZBURG

Today, visit Würzburg, a city in Bavaria known for lavish architecture, located in the center of the Franconian wine country. In the morning, experience the sights of the town as well as the Baroque Residence palace. The tour concludes with wine tasting in the ancient wine cellar of a local vineyard. As an alternate excursion, join the trip to the most romantic medieval town Rothenburg ob der Tauber, whose 42 towers, six awesome city gates, stone walls, and half-timbered gables have remained unchanged since the Thirty Years' War. Spend the afternoon relaxing back on board your floating luxury hotel.

DAY 7 | BAMBERG

Spend the morning cruising the scenic Main river. After lunch, arrive in the imperial city of Bamberg, a UNESCO World Cultural Heritage Site which retains its medieval layout of three settlement areas, along with its historic buildings and Baroque façades. Bamberg is ranked as one of Germany's most attractive towns and known for its deliciously smoky beer and stuffed onions. This German town is also the place to begin your crossing of the Rhine-Main-Danube canal.

This evening, join a presentation about the Main-Danube canal, which allows free flow of traffic between the North Sea and the Black Sea. It is your last night aboard, so let our Chefs delight you with their culinary magic at the Captain's Gala Dinner.

DAY 8 | NUREMBERG

After breakfast, the entire AMADEUS crew thanks you for your patronage, bids you farewell and wishes you a safe journey.

Castle Katz in the Upper Middle Rhine Valley



Cruise fares per person in EUR based on double occupancy of a cabin

TOUR DATE	VESSEL	CABIN TYPE & DECKS					
		C-4 Haydn	C-1 Haydn	B-4 Strauss	B-1 Strauss	A-1 Mozart	Suite Mozart
8 days Amsterdam – Nuremberg							
09.05. – 16.05.	AMADEUS Riva	2.079	2.399	2.799	3.049	3.359	3.969
27.07. – 03.08.	AMADEUS Cara	1.969	2.289	2.669	2.899	3.189	3.769

Early booking discount of 15% on the above-mentioned prices when booked by **Nov 30, 2023**.

Single cabin supplement per person for all dates:

C-4+C-1: 15%, B-4: 30%, B-1: 50%, A-1: 60%, Suite: 100% of cruise price.

For cruise price inclusions, see page 16, for deck plans see page 118–131.

Excursion packages prices per person in EUR and if booked in advance

Cruise Amsterdam – Nuremberg	UP	A	B	C
Amsterdam with canal trip and Holland Waterland	78	●	●	●
Cologne walking tour and Kölsch tasting	44	●	●	●
Siebengebirge and Drachenfels castle ruins	81		●	●
Rüdesheim with Music Cabinet Museum	33		●	
or Rüdesheim wine tasting & Drosselgasse	50			●
Miltenberg and Wertheim with glass museum	48	●	●	●
Würzburg walking tour with Residence and wine tasting	69			●
or Medieval Rothenburg ob der Tauber	45		●	
Bamberg walking tour	34	●	●	●
Excursion packages with 15% discount*		173	309	343

*compared to the unit price (UP) on board.

Package A with 4 excursions, Package B with 7 excursions and Package C with 7 excursions.

Please refer to pages 132 – 147 for specific shore excursion details.

Transfers prices per person in EUR

Amsterdam: train station – vessel	50
Amsterdam: airport – vessel	59
Nuremberg: vessel – train station	75
Nuremberg: vessel – airport	75

Saar and Moselle Fairytales

8 days | Cologne – Saarlouis – Cologne

15%
Early Booking
Discount



Our cruises along the river Saar take you to the heart of Europe and are a real treat for wine connoisseurs and nature lovers. Perfectly situated in the border region between Germany, Luxembourg and France, the Saar offers romantic landscapes along the tranquil, winding river. The picturesque Saar Loop with its ancient castles and the inviting vineyards full of fruit-ripe grapes await you on this journey. Enjoy a romantic and exiting cruise along the Rhine, the Moselle and the Saar while discovering the cultural highlights of Saarburg, Trier and Saarlouis.

The landscape of the Bremmer Moselschleife gets its special character from the steep vineyard slopes of the Calmont.

Your itinerary

DAY/PORT	ARR	DEP	HIGHLIGHTS OF THE PROGRAM
1 Cologne		22:00	Embarkation from 4 pm Welcome Cocktail and Welcome Dinner
2 Cochem	13:00	22:00	Scenic cruising on the Moselle River • Cochem walking tour & Reichsburg Castle • Tasting of typical Moselle wines in a local winery
3 Bernkastel Saarburg	08:00 22:00	12:00	• Bernkastel walking tour with wine tasting
4 Saarburg Saarlouis		13:00 20:00	• Saarburg walking tour Panoramic passage of the Great Saar Bend
5 Saarlouis Grevenmacher		12:00 22:00	• Fortified Saarlouis with chocolate tasting Panoramic passage of the Great Saar Bend
6 Grevenmacher Trier		12:00 14:00 18:00	• Grevenmacher and the Luxembourg Moselle • Excursion to Luxembourg • Trier – Germany’s oldest city
7 Koblenz	15:00	22:00	Scenic cruising on the Moselle River • Koblenz walking tour Captain’s Gala Dinner
8 Cologne	05:00		Disembarkation after breakfast

Excursions listed in blue are not included in the cruise price. Please refer to pages 132 – 147 for specific shore excursion details. We reserve the right to make amendments to the timetable and program.

Price per person in double cabin from **1.609,-**€





Vineyard landscape near Grevenmacher on the Moselle river in Luxembourg

Your day program Cruise Cologne – Saarlouis – Cologne

DAY 1 | GERMANY: COLOGNE

Your cruising adventure begins in Cologne, where you will embark in the afternoon. Enjoy a Welcome Cocktail, followed by a delicious Welcome Dinner.

DAY 2 | COCHEM

During the morning, your luxury vessel will take you on a scenic cruise down the Rhine's largest tributary, the Moselle River, famous for its picturesque landscape dominated by vineyards since Roman times. After your ship docks at Cochem, you can take the guided walking tour to discover the history seeping through Cochem's narrow alleys, medieval town gates, churches and more. You will also visit the imperial Reichsburg Castle, which towers above Cochem on an imposing crag. Wind down at dinner with your fellow guests as your AMADEUS ship travels onward.

DAY 3 | BERNKASTEL · SAARBURG

In the morning, you will arrive at another medieval wine-growing town called Bernkastel-Kues, which is known for its medieval marketplace and its gabled houses, including the Spitzhäuschen (Pointed House). Take a trip around this charming town in the morning and enjoy the winetasting session, which is included in the guided tour. The afternoon is yours to spend relaxing on board, and late at night, your vessel will arrive in Saarburt.

*„Wonderful cruise!
Very enjoyable to see the country
of my ancestry.“*

Libby V.

DAY 4 | SAARBURG · SAARLOUIS

Start your day by exploring the sights of the German town of Saarburt on the banks of the Saar River. Don't miss the impressive 60-foot-drop that the river Leuk, which flows through Saarburt, makes in the town center. You will return to your vessel in time for lunch and then enjoy a panoramic cruise along the 'Saarschleife', or Great Bend in the Saar River, where the Saar has carved a massive loop through quartzite rock. End this eventful day with an elegant dinner on board in the company of your fellow guests.

A toast to the „queen of white wines“, the Riesling



DAY 5 | SAARLOUIS · LUXEMBOURG: GREVENMACHER

After breakfast, join us to explore Saarlouis. Here, French serenity and pleasure are simply part of life. Perhaps also because the city was once founded by the French Sun King Louis XIV, whose name it bears. Parts of the original fortress remain intact and give insight into the town's history. Famous German chocolate Schogetten and other classics are produced here, so have a taste of some cocoa treats of the Saarland. After lunch on board, your vessel will take another scenic turn on the Great Bend in the Saar River before heading to the famous Luxembourg.

DAY 6 | GREVENMACHER · GERMANY: TRIER

One of the smallest sovereign states in Europe, the Grand Duchy of Luxembourg, awaits you today. In the morning, you can choose between a visit to the town of Grevenmacher or join the excursion to Luxembourg City. Grevenmacher is a small town in eastern Luxembourg, in a romantic wine-growing region situated along the Moselle River. Luxembourg City is the capital of Luxembourg and houses the European Court of Justice. At lunchtime, you will rejoin your vessel and return to Germany, where you will dock in Trier. Don't miss the opportunity to explore this lovely city with a history that stretches back to Celtic times. Evidence of Roman times still lingers in the city, giving it the nickname „Rome of the North.“ Its Porta Nigra (black gate) is the largest Roman city gate north of the Alps.

DAY 7 | KOBLENZ

Enjoy a restful morning on board and admire the intimate charm of the Moselle River. Wending between vertiginous vine-covered slopes, the Moselle offers entrancing scenery around every hairpin bend: vine-ribboned hillsides, colorful half-timbered medieval villages, crumbling hilltop castles and elegant Jugendstil (art nouveau) villas. During mid-afternoon, you will make a stop in Koblenz, which is situated at the confluence of the Rhine and Moselle rivers. Overlooking the confluence, it's an observation platform in the shape of a ship's bow named Deutsches Eck (meaning "German Corner"). Join the guided town walk through Koblenz. Back on board, you will be treated to the festive Captain's Gala Dinner.

DAY 8 | COLOGNE

After breakfast, we bid you farewell.

Luxembourg's UNESCO-protected Grund district



Cruise fares per person in EUR based on double occupancy of a cabin

TOUR DATE	VESSEL	CABIN TYPE & DECKS					
		C-4* Haydn	C-1 Haydn	B-4 Strauss	B-1 Strauss	A-1 Mozart	Suite Mozart
8 days Cologne – Saarlouis – Cologne	AMADEUS Brilliant	1.609	1.869	2.179	2.369	2.599	3.079
10.05. – 17.05.	AMADEUS Brilliant	1.609	1.869	2.179	2.369	2.599	3.079
29.08. – 05.09.	AMADEUS Brilliant	1.689	1.969	2.289	2.489	2.739	3.239
28.09. – 05.10.	AMADEUS Brilliant	1.689	1.969	2.289	2.489	2.739	3.239

Early booking discount of 15% on the above-mentioned prices when booked by **Nov 30, 2023**. Single cabin supplement per person for all dates: C-4 + C-1: 15%, B-4: 30%, B-1: 50%, A-1: 60%, Suite: 100% of cruise price. *True single cabins with no single supplement available on AMADEUS Brilliant at the price of C-4 cabins.

For cruise price inclusions, see page 16, for deck plans see page 130.

Excursion packages prices per person in EUR and if booked in advance

Cruise Cologne – Saarlouis – Cologne	UP	A	B	C
Cochem walking tour & Reichsburg Castle	45	●	●	●
Tasting of typical Moselle wines in a local winery	18			●
Bernkastel walking tour with wine tasting	46			●
Saarburt walking tour	24	●	●	●
Fortified Saarlouis with chocolate tasting	34	●	●	●
Grevenmacher and the Luxembourg Moselle or Excursion to Luxembourg	45 54		●	●
Trier – Germany's oldest city	52	●	●	●
Koblenz walking tour	24	●	●	●
Excursion packages with 15% discount*		152	190	252

*compared to the unit price (UP) on board. Package A with 5 excursions, Package B with 6 excursions and Package C with 8 excursions. Please refer to pages 132 – 147 for specific shore excursion details.

Transfers prices per person in EUR

Cologne: train station – vessel or v.v.	36
Colgone: airport – vessel or v.v.	46

Rhine & Danube Symphony

8 days | Cologne – Passau or Passau – Cologne



This one-week cruise combines the majesty of two great European rivers – the Rhine and the Danube. Explore the Upper Middle Rhine Valley with its numerous castles and experience the tranquil meandering of the Main. Travel the man-made Main-Danube canal – a stunning technological marvel – as you transit onto the beautiful Danube River. Discover the half-timbered buildings of Miltenberg and Wertheim, along with the UNESCO World Heritage Sites of Würzburg, Bamberg and Regensburg.

Würzburg's Marienberg Fortress on the left bank of the Main River

Your itinerary

COLOGNE – PASSAU

DAY/PORT	ARR	DEP	HIGHLIGHTS OF THE PROGRAM
1 Cologne		18:00	Embarkation from 4 pm Welcome Cocktail and Welcome Dinner
2 Rüdesheim	11:30	16:00	Cruise through the Upper Middle Rhine Valley • Rüdesheim with Music Cabinet Museum or Rüdesheim wine tasting & Drosselgasse
3 Miltenberg Wertheim	11:00 17:00	13:00 18:15	• Miltenberg and Wertheim with glass museum Rejoin the ship
4 Würzburg	08:00	18:00	• Würzburg walking tour with Residence and wine tasting • Medieval Rothenburg ob der Tauber
5 Bamberg	15:00	19:00	• Bamberg walking tour Onboard talk about the Main-Danube canal
6 Nuremberg	05:00	13:00	• Nuremberg – capital of Franconia Captain's Gala Dinner
7 Regensburg	08:00	18:00	• Regensburg walking tour • Thurn & Taxis Palace, brewery with tasting or Visit to Weltenburg Abbey Bavarian evening with regional specialities and local music on board
8 Passau	08:00		Disembarkation after breakfast

Excursions listed in blue are not included in the cruise price. Please refer to pages 132 – 147 for specific shore excursion details. We reserve the right to make amendments to the timetable and program. For the Passau – Cologne itinerary, see pages 44 – 45.

Price per person in double cabin from **1.609,-**€





© DZI/Francesco Carovillano

The landmarks of Regensburg are the Cathedral of St. Peter and the Stone Bridge from the 12th century.

Your day program Cruise Cologne – Passau

DAY 1 | GERMANY: COLOGNE

The historic city of Cologne is the starting point of your 8-day European cruise. After embarkation, enjoy a Welcome Cocktail followed by a delicious Welcome Dinner.

DAY 2 | RÜDESHEIM

Relax on board this morning while cruising through the fairytale landscape of the Upper Middle Rhine valley. Learn about the Lorelei, the nymph who, legends say, enticed sailors with her song and beauty. After lunch, the wine-making town of Rüdesheim awaits you. Discover the region's rich history on a morning walking tour and discover the world of self-playing instruments during your visit of the fascinating Music Cabinet Museum. Alternatively, take a tram ride on the "Wine Express" through the vineyards of Rüdesheim, sample fine wines and stroll along the quaint "Drosselgasse", mentioned in the 15th century as an alley used by Rhine boatmen. Enjoy a delectable dinner on board in the evening.

DAY 3 | MILTENBERG · WERTHEIM

In the late morning, your vessel arrives in Miltenberg. After lunch, join the excursion to explore its timber-frame houses that evoke 16th and 17th century Germany.

"When I'm abroad, I want to really immerse in the local culture. With its true European heritage AMADEUS provides this experience best."

Richard B.

Continue to Wertheim and stroll through its medieval streets. Visit the Glass Museum and learn about the use of glass as a material from antiquity to today's high-tech products. This evening, enjoy another memorable dinner as the ship plies the waters toward our next stop.

DAY 4 | WÜRZBURG

In the morning, your vessel docks in Würzburg, a city known for lavish Baroque and Rococo architecture, located in the heart of Franconian wine country. On the morning tour, view the beautiful sights of the town including the Residence, a Baroque

palace considered a masterpiece of its era. The tour concludes with wine tasting in the ancient wine cellar of a local vineyard. In the afternoon, join the trip to one of the best-preserved medieval towns in Europe, the old Bavarian Imperial City of Rothenburg ob der Tauber, whose towers, city gates, town walls, and half-timbered gables have remained unchanged by the hands of time.

DAY 5 | BAMBERG

The morning is spent cruising the scenic Main River. After lunch, your vessel will arrive in the Imperial city of Bamberg, a UNESCO World Cultural Heritage Site. Bamberg survived all the wars of the past centuries largely untouched and can be experienced as it was centuries ago. Upon arrival, discover its

Moments of pleasure on the Sun Deck



architectural charm on a walking tour. This evening, attend the onboard presentation about the creation and importance of the Main-Danube canal as we enter the waterway to cross onto the Danube River.

DAY 6 | NUREMBERG

Following breakfast, join the excursion to the romantic old town of Nuremberg, lovingly restored after the destruction incurred during World War II. The city is a historical leader in mechanical invention, science, printing, and humanism. Pass by the Palace of Justice, the venue of the Nuremberg trials, and discover the old town with a walk through the narrow medieval alleyways. Interestingly, the Old Town of Nuremberg is divided into two sections by the Pegnitz River. Back on board, as you enjoy the Captain's Gala Dinner, your vessel continues to Regensburg.

DAY 7 | REGENSBURG

Regensburg, one of Germany's best-preserved medieval cities, awaits you today. This UNESCO World Heritage Site boasts architecture from many centuries, reflective of its varied history. The 12th-century stone bridge, the Church of St. James and patrician houses are a few of the highlights you can admire on the walking tour. In the afternoon, choose between a visit to the 600-year-old Weltenburg Abbey, which is situated on the banks of the Danube and houses the oldest monastic brewery in the world, and a trip to the 18th century Thurn and Taxis Palace with a stop at their traditional brewery and beer tasting. Back on board, get into the spirit of "Oktoberfest" at the Bavarian-themed evening, with authentic German beer on tap and freshly baked pretzels.

DAY 8 | PASSAU

This morning, your vessel arrives in Passau. After breakfast we wish you a good trip home and hope to see you again soon!

Nuremberg: Weinstadt and Hangman's Tower



Cruise fares per person in EUR based on double occupancy of a cabin

TOUR DATE	VESSEL	CABIN TYPE & DECKS					
		C-4* Haydn	C-1 Haydn	B-4 Strauss	B-1 Strauss	A-1 Mozart	Suite Mozart
8 days Cologne – Passau							
28.06. – 05.07.	AMADEUS Brilliant	1.689	1.969	2.289	2.489	2.739	3.239
19.09. – 26.09.	AMADEUS Queen	1.879	2.189	2.549	2.769	3.049	3.599
05.10. – 12.10.	AMADEUS Brilliant	1.609	1.869	2.179	2.369	2.599	3.079
8 days Passau – Cologne							
22.08. – 29.08.	AMADEUS Brilliant	1.609	1.869	2.179	2.369	2.599	3.079

Early booking discount of 15% on the above-mentioned prices when booked by **Nov 30, 2023**.

Single cabin supplement per person for all dates:

C-4+C-1: 15%, B-4: 30%, B-1: 50%, A-1: 60%, Suite: 100% of cruise price.

*True single cabins with no single supplement available on *AMADEUS Brilliant* at the price of C-4 cabins.

For cruise price inclusions, see page 16, for deck plans see page 118–131.

Excursion packages prices per person in EUR and if booked in advance

Cruises Cologne – Passau and Passau – Cologne	UP	A	B	C
Rüdesheim with Music Cabinet Museum	33	●	●	●
or Rüdesheim wine tasting & Drosselgasse	50			●
Miltenberg and Wertheim with glass museum	48	●	●	●
Würzburg walking tour with Residence and wine tasting	69	●	●	●
Medieval Rothenburg ob der Tauber	45			●
Bamberg walking tour	34	●	●	●
Nuremberg – capital of Franconia	52		●	●
Regensburg walking tour	24	●	●	●
Thurn & Taxis Palace, brewery with tasting	76			●
or Visit to Weltenburg Abbey	45		●	
Excursion packages with 15% discount*		177	259	338

*compared to the unit price (UP) on board.

Package A with 5 excursions, Package B with 7 excursions and Package C with 8 excursions. Please refer to pages 132 – 147 for specific shore excursion details.

Transfers prices per person in EUR

Cologne: train station – vessel or v.v.	36	Passau: vessel – train station or v.v.	28
Cologne: airport – vessel or v.v.	46	Passau: vessel – Munich airport or v.v.	109

Your itinerary

PASSAU – COLOGNE

DAY/PORT	ARR	DEP	HIGHLIGHTS OF THE PROGRAM
1 Passau		17:00	Embarkation from 4 pm Welcome Cocktail and Welcome Dinner
2 Regensburg	09:00	18:00	<ul style="list-style-type: none"> • Regensburg walking tour • Thurn & Taxis Palace, brewery with tasting or Visit to Weltenburg Abbey
3 Nuremberg	14:00	19:00	<ul style="list-style-type: none"> • Nuremberg – capital of Franconia Bavarian evening with regional specialities and local music on board
4 Bamberg	08:00	11:00	<ul style="list-style-type: none"> • Bamberg walking tour Onboard talk about the Main-Danube canal
5 Würzburg	09:00	20:00	<ul style="list-style-type: none"> • Würzburg walking tour with Residence and wine tasting • Medieval Rothenburg ob der Tauber
6 Wertheim Miltenberg	10:00 17:30	13:30 18:00	<ul style="list-style-type: none"> • Wertheim with glass museum and Miltenberg Rejoin the ship
7 Rüdesheim	10:00	14:00	<ul style="list-style-type: none"> • Rüdesheim with Music Cabinet Museum or Rüdesheim wine tasting & Drosselgasse Cruise through the Upper Middle Rhine Valley Captain's Gala Dinner
8 Cologne	00:01		Disembarkation after breakfast

Excursions listed in blue are not included in the cruise price. Please refer to pages 132 – 147 for specific shore excursion details. We reserve the right to make amendments to the timetable and program. For cruise fares and excursion packages, see page 43.

Miltenberg: the beautiful old town is characterized by old half-timbered houses, churches and city walls



Your day program

DAY 1 | GERMANY: PASSAU

Beautiful Passau is the starting point for your 8-day European cruise to Cologne. After embarkation, enjoy a Welcome Cocktail and get to know your fellow travelers during the Welcome Dinner.

DAY 2 | REGENSBURG

This morning, your AMADEUS vessel arrives in one of Germany's best-preserved medieval cities. On the morning tour, immerse yourself in the historic atmosphere of this unique town, which boasts architecture from many different centuries and a 12th century bridge. In the afternoon, choose between a visit to the 600-year-old Weltenburg Abbey, which is situated on the banks of the Danube and houses the oldest monastic brewery in the world, and a trip to the 18th century Thurn and Taxis Palace with a stop at their traditional brewery and beer tasting.

DAY 3 | NUREMBERG

After a relaxing morning on board, spend your afternoon in Nuremberg. The city is a historical leader in mechanical invention, science, printing, and humanism. Enjoy an overview of the city's history and culture on a guided tour, and admire the romantic Old Town, lovingly restored after the destruction incurred during World War II. Interestingly, the Old Town of Nuremberg is divided into two sections by the Pegnitz River. Back on board, enjoy dinner as the vessel departs Nuremberg. This evening, enjoy a



The Niederwald Monument over the vineyards of the Rüdesheim hill

special Bavarian theme on board with regional delicacies and live traditional music.

DAY 4 | BAMBERG

Your vessel arrives in the Imperial city of Bamberg in the morning. This medieval town is a UNESCO World Cultural Heritage site, which retains its medieval layout of three settlement areas, along with its historic buildings and Baroque façades, all of which you can explore on a guided walking tour. The ornate town hall, the old town with its half-timbered buildings and pretty arched bridges are so romantic! Back on board, you Cruise Director will elaborate on the importance of the Main-Danube canal during an onboard talk, while your AMADEUS ship continues along the Main River.

A toast in the Rüdesheimer Drosselgasse



"Cruising through some of the best wine-growing regions in Germany is almost as good as tasting them."

Sarah A. & Kenneth S.

DAY 5 | WÜRZBURG

Today, spend the day alongside in Würzburg, a city in Bavaria known for lavish Baroque and Rococo architecture, located in the center of the Franconian wine country. In the morning, experience the many beautiful sights of the town as well as the Residenz, a Baroque palace considered a masterpiece of that era. The tour concludes with a wine tasting in the ancient wine cellar of a local vineyard. In the afternoon, relive a bygone era on a tour of

Rothenburg ob der Tauber, whose towers, city gates, and half-timbered gables have remained unchanged by the hands of time.

DAY 6 | WERTHEIM · MILTENBERG

Today, join the excursion to Wertheim and Miltenberg, two towns famous for their architecture and museums. Both are unique in their own way and are reflective of the storied history of the area. Begin with a walking tour in Wertheim and explore the medieval streets and unique glass museum. In Miltenberg, admire the typical 16th and 17th century German timberframe houses and stroll through the cobblestone alleys.

DAY 7 | RÜDESHEIM

In the morning, you arrive in Rüdesheim, a romantic winemaking town in the Rhine Gorge where the river landscape has enchanted visitors for centuries and which is protected by UNESCO since 2002. Discover the region's rich history on a morning walking tour and visit the fascinating Music Cabinet Museum. Alternatively, take a tram ride through the vineyards of Rüdesheim on the "Wine Express" and stroll along the quaint "Drosselgasse", mentioned in the 15th century as an alley used by Rhine boatmen to reach their homes. After lunch, enjoy the fairytale landscape of the Upper Middle Rhine Valley with its many castles as your vessel cruises downriver to Cologne. This evening, celebrate your cruise experience at the Captain's Gala Dinner.

DAY 8 | COLOGNE

Shortly after midnight you arrive in the cathedral city of Cologne. After breakfast, the entire AMADEUS crew bids you farewell.

German Riverscapes

9 days | Passau – Trier or Trier – Passau



This cruise showcases the majesty of three great European rivers – the Moselle, the Main and the Danube. Travel the man-made Main-Danube canal – a stunning technological marvel – as you transit from the beautiful Danube River. Explore the upper middle Rhine Valley with its numerous castles and experience the tranquil meandering of the Main. Discover the half-timbered buildings of Miltenberg and Wertheim, along with the UNESCO World Heritage Sites of Würzburg, Bamberg and Regensburg. Another sight of this cruise is the region that has been considered the best place for Riesling in the world: the romantic vineyards and villages of the Moselle River.

Martin de Bock

Your itinerary

PASSAU – TRIER

DAY/PORT	ARR	DEP	HIGHLIGHTS OF THE PROGRAM
1 Passau		19:00	Embarkation from 4 pm Welcome Cocktail and Welcome Dinner
2 Regensburg	10:00	18:00	<ul style="list-style-type: none"> • Regensburg walking tour • Thurn & Taxis Palace, brewery with tasting or Visit to Weltenburg Abbey
3 Nuremberg	13:30	19:30	<ul style="list-style-type: none"> • Nuremberg – capital of Franconia Bavarian evening with regional specialities and local music on board
4 Bamberg	08:30	12:30	<ul style="list-style-type: none"> • Bamberg walking tour Onboard talk about the Main-Danube canal
5 Ochsenfurt Würzburg	06:00 12:30	09:30 18:00	<ul style="list-style-type: none"> • Medieval Rothenburg ob der Tauber • Würzburg walking tour with Residence and wine tasting
6 Wertheim Miltenberg	08:00 13:30	09:00 14:00	<ul style="list-style-type: none"> • Wertheim with glass museum and Miltenberg Rejoin the ship
7 Oberwesel Koblenz	09:00 17:00	14:00	<ul style="list-style-type: none"> • Oberwesel walking tour Cruise through the Upper Middle Rhine Valley • Koblenz walking tour
8 Koblenz Cochem		06:00 17:00	<ul style="list-style-type: none"> • Scenic cruising on the Moselle River • Cochem walking tour & Reichsburg Castle or Tasting of typical Moselle wines in a local winery Captain's Gala Dinner
9 Trier	11:00		Disembarkation after breakfast

Excursions listed in blue are not included in the cruise price. Please refer to pages 132 – 147 for specific shore excursion details. We reserve the right to make amendments to the timetable and program. For the Trier – Passau itinerary, see pages 50 – 51.

Price per person in double cabin from **1.249,-**€



The AMADEUS vessel on the Rhine River



The Weltenburg Monastery is located in the nature-protected Danube breakthrough of the „Weltenburger Enge“

Your day program Cruise Passau – Trier

DAY 1 | GERMANY: PASSAU

Start your 9-day European cruise in the city of Passau. After embarkation, meet your fellow travelers at a Welcome Cocktail, followed by a delectable Welcome Dinner.

DAY 2 | REGENSBURG

In the morning, your AMADEUS cruise ship arrives in Regensburg, one of Germany's best-preserved medieval towns. During the morning walking tour, you can admire this UNESCO World Heritage Site, which boasts architecture from many different centuries. In the afternoon, choose between a visit to the 600-year-old Weltenburg Abbey, situated on the banks of the Danube, and a trip to the 18th century Thurn and Taxis Palace with a stop at their traditional brewery and a tasting.

DAY 3 | NUREMBERG

After lunch, enjoy your afternoon in Nuremberg, either on your own or as part of the guided city tour. The romantic old town was lovingly restored after the destruction incurred during World War II. Pass by the Palace of Justice, the venue of the Nuremberg trials, and walk through the narrow medieval alleyways starting at the foot of the castle. Once you have returned to your ship, enjoy a special Bavarian evening on board.

DAY 4 | BAMBERG

During breakfast, your vessel arrives in the Imperial town of Bamberg. This medieval town has retained its medieval layout, along with its historic buildings and Baroque façades. Join our walking tour and learn more

about the development of this historically significant city, whose old town was named a UNESCO World Heritage Site in 1993. Admire the seven hills of Bamberg, each topped with a stunning church. After rejoining your vessel, enjoy a relaxing afternoon cruising and join a presentation about the creation and importance of the Main-Danube Canal.

DAY 5 | OCHSENFURT · WÜRZBURG

Ochsenfurt is your gateway to a choice of two morning excursions. Travel overland by bus to Rothenburg ob der Tauber, a well-preserved medieval town whose towers, city gates, walls and half-timbered gables have remained un-

Afternoon coffee on the sun deck



"I love seeing Europe from the perspective of its waterways. It is my new favorite way to travel."

Anthony B.

changed. After your tour, join the vessel for lunch in Würzburg, a Bavarian town known for its lavish Baroque and Rococo architecture. This afternoon, explore the city on your own or join the guided walking tour, which includes a visit to the Residence, where you can learn about "Würzburg Rococo" – the most exuberant of all the variations of this style in Germany. The tour concludes with a wine tasting in the ancient wine cellar of a local vineyard. Your vessel departs Würzburg before dinner this evening.

DAY 6 | WERTHEIM · MILTENBERG

In the morning, you can join the excursion to Wertheim and Miltenberg, two towns picturesque surrounded by forests and famous for their architecture and museums. Both are unique in their own way and reflect the history of the area. Begin with a walking tour in Wertheim and explore its medieval streets and unique glass museum. In Miltenberg, see the timber-framed houses dating back to the 16th and 17th centuries. Rejoin your vessel at lunchtime and spend the afternoon relaxing on board, cruising the Main River.

DAY 7 | OBERWESEL · KOBLENZ

After breakfast, your AMADEUS vessel docks in Oberwesel, the "City of Towers", which you can discover during a morning walking tour. In the afternoon, you'll want to have a camera at-the-ready for the most beautiful section of the river – the legendary Upper Middle Rhine Valley. With its castles, historic towns and vineyards, this beautiful valley is filled with a dramatic and varied natural landscape. In the late afternoon, take part in the walking tour to the 2,000-years-old city of Koblenz.

DAY 8 | KOBLENZ · COCHEM

Your vessel departs Koblenz early in the morning. Admire the scenery of the winding river with the steep slate slopes of the Moselle Valley during the panoramic cruise to Cochem. After lunch, take part in a walking tour and explore Cochem's narrow streets, winding alleyways, quaint churches, and medieval town gates, as well as Reichsburg castle, which offers unparalleled views over lush terraced vineyards. Alternatively, visit a local winery and taste the famous Moselle wines, before returning to your ship. To end the day, celebrate at the Captain's Gala Dinner.

DAY 9 | TRIER

This morning, your vessel arrives in Trier. After breakfast we wish you a good trip home and hope to see you again soon!

Wertheim castle high above the town



Cruise fares per person in EUR based on double occupancy of a cabin

TOUR DATE	VESSEL	CABIN TYPE & DECKS					
		C-4* Haydn	C-1 Haydn	B-4 Strauss	B-1 Strauss	A-1 Mozart	Suite Mozart
9 days Passau – Trier							
14.06. – 22.06.	AMADEUS Riva	1.389	1.819	2.339	2.569	2.869	3.539
06.08. – 14.08.	AMADEUS Brilliant	1.249	1.639	2.099	2.309	2.589	3.189
9 days Trier – Passau							
14.08. – 22.08.	AMADEUS Brilliant	1.249	1.639	2.099	2.309	2.589	3.189

Early booking discount of 15% on the above-mentioned prices when booked by **Nov 30, 2023**. Single cabin supplement per person for all dates: C-4 + C-1: 15%, B-4: 30%, B-1: 50%, A-1: 60%, Suite: 100% of cruise price. *True single cabins with no single supplement available on AMADEUS Brilliant at the price of C-4 cabins.

For cruise price inclusions, see page 16, for deck plans see page 118–131.

Excursion packages prices per person in EUR and if booked in advance

Cruise Passau – Trier	UP	A	B	C
Regensburg walking tour	24	●	●	●
Thurn & Taxis Palace, brewery with tasting or Visit to Weltenburg Abbey	76 45		●	●
Nuremberg – capital of Franconia	52	●	●	●
Bamberg walking tour	34		●	●
Medieval Rothenburg ob der Tauber	45			●
Würzburg walking tour with Residence and wine tasting	69	●	●	●
Wertheim with glass museum and Miltenberg	48	●	●	●
Oberwesel walking tour	24			●
Koblenz walking tour	24		●	●
Cochem walking tour & Reichsburg Castle or Tasting of typical Moselle wines in a local winery	45 18	●	●	●
Excursion packages with 15% discount*		202	267	375
Cruise Trier – Passau	UP	A	B	C
Cochem walking tour & Reichsburg Castle or Tasting of typical Moselle wines in a local winery	45 18	●	●	●
Koblenz walking tour and Ehrenbreitstein Fortress	52		●	●
Miltenberg and Wertheim with glass museum	48	●	●	●
Würzburg walking tour with Residence and wine tasting	69	●	●	●
Medieval Rothenburg ob der Tauber	45			●
Bamberg walking tour	34		●	●
Nuremberg – capital of Franconia	52	●	●	●
Regensburg walking tour	24	●	●	●
Thurn & Taxis Palace, brewery with tasting or Visit to Weltenburg Abbey	76 45		●	●
Excursion packages with 15% discount*		202	291	378

*compared to the unit price (UP) on board.

– Cruise Passau – Trier: Package A with 5, Package B with 8 and Package C with 10 excursions, – Cruise Trier – Passau: Package A with 5, Package B with 8 and Package C with 9 excursions.

Please refer to pages 132 – 147 for specific shore excursion details.

Transfers prices per person in EUR

Passau: train station – vessel or v.v.	28
Munich airport – vessel/Passau or v.v.	109

Your itinerary

TRIER – PASSAU

DAY/PORT	ARR	DEP	HIGHLIGHTS OF THE PROGRAM
1 Trier		16:00	Embarkation from 4 pm Welcome Cocktail and Welcome Dinner
2 Cochem	07:00	13:30	<ul style="list-style-type: none"> • Cochem walking tour & Reichsburg Castle or Tasting of typical Moselle wines in a local winery Scenic cruising on the Moselle River
Koblenz		22:00	
3 Koblenz		13:00	<ul style="list-style-type: none"> • Koblenz walking tour and Ehrenbreitstein Fortress Cruise through the Upper Middle Rhine Valley
4 Miltenberg Wertheim	14:00 19:00	14:30 19:30	<ul style="list-style-type: none"> • Miltenberg and Wertheim with glass museum Rejoin the ship
5 Würzburg	08:00	18:00	<ul style="list-style-type: none"> • Würzburg walking tour with Residence and wine tasting • Medieval Rothenburg ob der Tauber
6 Zeil am Main Bamberg	13:00 18:30	13:30 19:00	<ul style="list-style-type: none"> • Bamberg walking tour Rejoin the ship
7 Nuremberg	07:00	13:00	<ul style="list-style-type: none"> • Nuremberg – capital of Franconia Onboard talk about the Main-Danube canal Captain's Gala Dinner
8 Regensburg	09:00	20:00	<ul style="list-style-type: none"> • Regensburg walking tour • Thurn & Taxis Palace, brewery with tasting or Visit to Weltenburg Abbey Bavarian evening with regional specialities and local music on board
9 Passau	09:00		Disembarkation after breakfast

Excursions listed in blue are not included in the cruise price. Please refer to pages 132 – 147 for specific shore excursion details. We reserve the right to make amendments to the timetable and program. For cruise fares and excursion packages, see page 49.

Bamberg's landmark: the Old Town Hall in the middle of the Regnitz River



Your day program

DAY 1 | GERMANY: TRIER

Begin your cruise in the German city of Trier. Embark in the afternoon and enjoy the scenery cruise along the beautiful Moselle. Celebrate your cruise with a Welcome Cocktail and a sumptuous Welcome Dinner.

DAY 2 | COCHEM · KOBLENZ

In the morning, your vessel arrives in Cochem in the vine-covered Moselle Valley. Take part in a walking tour and explore the narrow streets, winding alleyways, quaint churches, and medieval town gates, as well as Reichsburg castle, which offers unparalleled views over lush terraced vineyards. Alternatively, visit a local winery and taste typical Moselle wines of the region, before returning to your ship, which departs at lunch. Enjoy the afternoon cruising through the magnificent countryside before arriving in Koblenz late this evening.

DAY 3 | KOBLENZ

Explore Koblenz, one of the oldest towns in Germany. On a morning tour, discover the UNESCO sites along its romantic streets, such as the St. Castor Basilica, the Church of our Beloved Lady, and the Schängel Fountain. Continue by cable car up to Ehrenbreitstein Fortress, the second largest preserved fortress in Europe, dating back to 1,000 AD. After lunch, your vessel continues along the Upper



Bacharach on the Rhine: small, cozy town with historic alleys and many half-timbered...

Middle Rhine Valley. Enjoy the fairytale landscape with its many castles and look out for the myth-enshrouded Lorelei cliff. Enjoy dinner with your fellow cruisers this evening.

DAY 4 | MILTENBERG · WERTHEIM

Spend a tranquil morning on board enjoying the beautiful scenery of the Main River. After lunch, the ship will dock in Miltenberg. This afternoon, discover the beauty of the town with its streets of 17th and 18th century half-timbered houses on a guided tour, before heading off to Wertheim by bus. Stroll through the medieval streets of Wertheim, visit the Angel's Fountain and pay a visit to the glass museum. Your ship will depart Miltenberg and continue to Wertheim, where you will rejoin for dinner, before continuing along the river.

DAY 5 | WÜRZBURG

A busy day awaits you as your ship arrives this morning in Würzburg. Located in the

heart of the Franconian wine district, this Bavarian town is known for its lavish Baroque and Rococo architecture. Admire the sights on the morning tour, including the Residence, a Baroque palace considered to be a masterpiece of that era. The tour concludes with a wine tasting in the ancient wine cellar of a local vineyard. Continue your explorations

"Looking outside my cabin window it looks like a living picture postcard."

Peter M.

with the afternoon tour to Rothenburg ob der Tauber, one of Germany's best-preserved medieval towns.

After the guided tour, enjoy some free time, before a bus takes you back to your ship in Würzburg, where a delicious dinner awaits.

The Würzburg Residence is considered a masterful synthesis of the European Baroque



DAY 6 | ZEIL AM MAIN · BAMBERG

After a relaxing morning on board you can join the afternoon excursion to the idyllic mountain town of Bamberg. After lunch, a bus will collect you from Zeil am Main and take you to the UNESCO World Heritage town of Bamberg. Experience its culture and architecture firsthand as you stroll through the small, romantic streets. After the walking tour, admire the seven hills of Bamberg, each topped with a church, and perhaps enjoy a beer from one of the many local breweries. In the meantime, your ship will make its way to Bamberg, where you will re-board in the evening before dinner.

DAY 7 | NUREMBERG

The former Imperial city of Nuremberg awaits you today. After breakfast, explore the city on the morning tour, admiring the romantic old town, the Palace of Justice, and more. After lunch on board, learn more about the Main-Danube canal in a presentation. This evening, celebrate your cruise at the festive Captain's Gala Dinner.

DAY 8 | REGENSBURG

In the morning, your vessel arrives in Regensburg, one of Germany's best-preserved medieval towns. On the morning tour, you can immerse yourself in the historic atmosphere of this unique town, which boasts architecture from many different centuries and a bridge that has spanned the Danube since the 12th century. In the afternoon, choose between a visit to the 600-year-old Weltenburg Abbey, situated on the banks of the Danube, and a trip to the 18th century Thurn and Taxis Palace with a stop at their traditional brewery and a beer tasting. Once you return on board, the excitement is not over yet for the day, as a traditional Bavarian evening awaits you.

DAY 9 | PASSAU

After breakfast, we bid you farewell.

Across Europe

15 days | Amsterdam – Budapest

15%
Early Booking
Discount

Spanning 2,000 kilometers across Europe, from Amsterdam at the North Sea to Budapest the “Queen of the Danube”, the castles lining the Rhine, Main and Danube rivers are testaments to the majesty of European history. The beauty of the Rhine with its castles and cathedral cities, the engineering feat of the Main-Danube canal and the wonders of the Danube River are all highlights along the way. Traverse five countries (Netherlands, Germany, Austria, Slovakia & Hungary) with visits to numerous capital cities, while passing through the unique landscapes of the myth-enshrouded Lorelei, the “Schlögenger Schlinge” below Passau, the picturesque UNESCO Wachau Valley region, and the Danube knee at Visegrád (the Hungarian Wachau). Dotted along the way is beautiful architecture – the yellow & white Melk Abbey and the stately Esztergom Basilica, high above the Danube. Join us as we witness several hundred years of history in the heart of Europe.

Schloss Johannisburg in Aschaffenburg am Main

Your itinerary

DAY/PORT	ARR	DEP	HIGHLIGHTS OF THE PROGRAM
1 Amsterdam			Embarkation from 4 pm · Welcome Cocktail and Welcome Dinner · Shanty Choir on board
2 Amsterdam Utrecht	11:30	08:30 12:30	• Amsterdam with canal trip and Holland Waterland Rejoin the ship
3 Cologne	10:00	20:00	• Cologne walking tour and Kölsch tasting • Siebengebirge and Drachenfels castle ruins
4 Rüdesheim	12:00	15:00	Cruise through the Upper Middle Rhine Valley • Rüdesheim with Music Cabinet Museum or Rüdesheim wine tasting & Drosselgasse
5 Miltenberg Wertheim	14:00 18:30	14:30 19:00	• Miltenberg and Wertheim with glass museum Rejoin the ship
6 Würzburg	09:00	13:00	• Würzburg walking tour with Residence and wine tasting • Medieval Rothenburg ob der Tauber
7 Bamberg	13:00	19:00	• Bamberg walking tour
8 Nuremberg	07:30	17:00	• Nuremberg – capital of Franconia • Visit to the World of Gingerbread or The Documentation Center of Nuremberg
9 Regensburg	13:00	22:00	• Regensburg walking tour or Thurn & Taxis Palace, brewery with tasting Bavarian evening with regional specialties and local music on board
10 Passau	12:00	16:00	• Passau walking tour
11 Emmersdorf Dürnstein Vienna	06:30 13:00 19:15	11:30 15:00	• Melk Abbey – A Baroque Jewel • Dürnstein walking tour with wine tasting • “Sound of Vienna” classical concert (cat. B)
12 Vienna		23:59	• Vienna – Imperial discovery tour • Visit to Schönbrunn Palace
13 Bratislava	07:00	20:00	• Bratislava – Beauty on the Danube • Schloss Hof – Baroque Palace and Estate or The Little Carpathian Wine Route
14 Budapest	08:30		• Budapest – Castle Hill & Historic Wonders • An Authentic Taste of Budapest or Visit to the Royal Palace of Gödöllő Captain’s Gala Dinner · Evening cruise Budapest with folklore show on board
15 Budapest			Disembarkation after breakfast

Excursions listed in blue are not included in the cruise price.

Please refer to pages 132 – 147 for specific shore excursion details.

We reserve the right to make amendments to the timetable and program.

Price per person in double cabin from **3.659,-** €

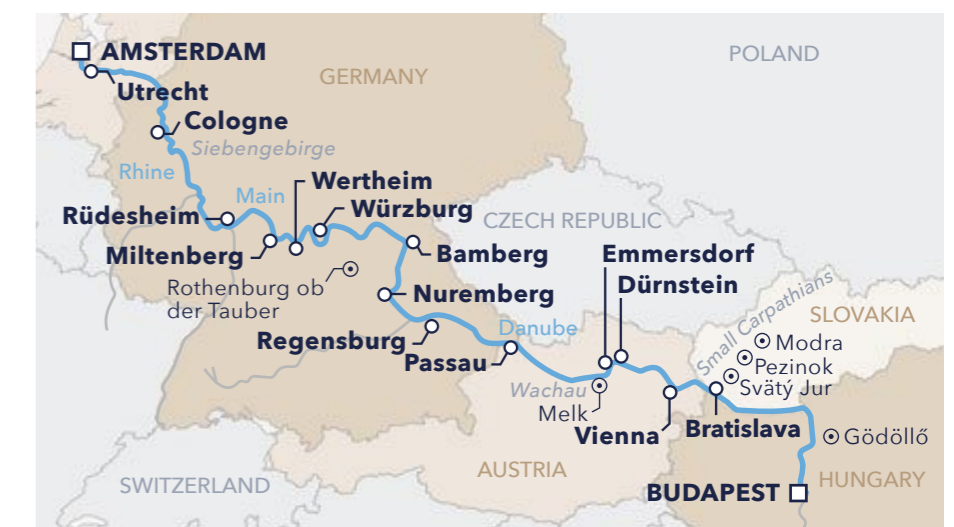



The Keizersgracht is the middle of the three main canals of the Amsterdam canal belt.

Your day program Cruise Amsterdam – Budapest

DAY 1 | NETHERLANDS: AMSTERDAM

Historic Amsterdam is the starting point of your European cruise. After embarkation, enjoy a Welcome Cocktail and Dinner. Sing along some sea shanties with a local choir this evening in the Panorama-Bar.

DAY 2 | AMSTERDAM · UTRECHT

In the morning, enjoy a boat trip along the famous Amsterdam canals followed by a trip to the peaceful countryside of the Waterland region. Enjoy the waterside of historic fishing villages and stroll along the long stretch of eateries. Rejoin your ship in Utrecht for lunch.

DAY 3 | GERMANY: COLOGNE

In the morning, you will arrive in beautiful Cologne. Discover the highlights of the city on the guided city tour. End with a glass of typical Kölsch, a famed Rhineland beer. Nature lovers will enjoy the excursion to the Siebengebirge National Park, Germany's first nature reserve, and to Drachenfels castle ruins. After an exciting day, return to the vessel to continue south along the river.

DAY 4 | RÜDESHEIM

The morning starts on a high note with the passage of the Lorelei in the Upper Middle Rhine Valley. At lunchtime, the vessel arrives in Rüdesheim, a picturesque wine-making town in the Rhine Gorge. Discover the region's rich history on a walking tour and admire the magical collection of instruments at the Music Cabinet Museum. Or choose to take a tram ride through the vineyards of Rüdesheim on the "Wine Express", enjoy some fine wine and stroll along the quaint "Drosselgasse".

DAY 5 | MILTENBERG · WERTHEIM

After a tranquil morning on board, join the afternoon excursion to Miltenberg and Wertheim. Miltenberg is a town flanked by the river Main and an incredible, forested hillside and features Miltenberg castle. Continue to Wertheim and explore the medieval streets with their half-timbered houses and the unique glass museum. This evening, enjoy another memorable meal as the ship plies the waters toward our next stop.

DAY 6 | WÜRZBURG

Today, visit Würzburg, a city in Bavaria known for lavish architecture, located in the center of the Franconian wine country. In the morning, experience the many beautiful sights of the town as well as the Residence, a Baroque palace. The tour concludes with wine tasting in the ancient wine cellar of a local vineyard. As an alternate excursion, join the trip to Rothenburg ob der Tauber, whose towers, city gates, walls, and half-timbered gables have remained unchanged. Relax on board this afternoon.

DAY 7 | BAMBERG

Spend the morning cruising the scenic Main river. After lunch, arrive in the imperial city of Bamberg, a UNESCO World Cultural Heritage

*"I loved everything about this cruise!
I will remember the beautiful
lounge and restaurant,
the delicious food & drinks,
the excellent service."*

Stephen H.

Site, which retains its medieval layout of three settlement areas, along with its historic buildings. It is ranked as one of Germany's most attractive towns and is also the place to begin your crossing of the Rhine-Main-Danube canal. Join a presentation about the canal which allows free flow of traffic between the North Sea and the Black Sea.

DAY 8 | NUREMBERG

The former imperial city of Nuremberg awaits you today with its turbulent history and sights. After breakfast, explore the city on the morning tour and admiring the romantic old town. In the afternoon, visit the World of Gingerbread to taste fresh Lebkuchen from the oven and learn about this sweet treat made of honey and spices. If you prefer, learn more about World War II and the Nazi past at the Documentation Center of Nuremberg. Back on board, we will go to the European watershed separating the Main and Danube rivers.

DAY 9 | REGENSBURG

Regensburg is one of Germany's best-preserved medieval cities. Choose to uncover the secrets of this remarkable UNESCO Site during a walking tour. Alternatively, visit the 18th century Thurn and Taxis Palace for a beer tasting in their traditional brewery. A special Bavarian themed evening celebrates this wonderful region.

DAY 10 | PASSAU

Arrive in time for lunch in the three-rivers city of Passau, lying at the confluence of the Danube, the Inn and the Ilz. In the afternoon, join the city walking tour, which showcases the most enchanting sights of this historic city including St. Stephen's Cathedral. Back on board, enjoy dinner.

DAY 11 | AUSTRIA: EMMERSDORF DÜRNSTEIN · VIENNA

In the early morning, dock in Emmersdorf, in the heart of the UNESCO-protected Wachau Valley. Spend the morning discovering this typical Lower Austrian town or travel across the river to Melk and its famous magnificent Benedictine abbey – the largest in Austria. Back on board for lunch, continue through the vineyards of the Wachau to the village of Dürnstein. Take a guided afternoon tour in the romantic village with its iconic blue church and winding streets, and sample the local wines. Upon arrival in Vienna, opt for the "Sound of Vienna" concert and listen to popular pieces from Vienna's classical era at a local salon. The vessel remains overnight.

DAY 12 | VIENNA

Enjoy the sights of Vienna on the "Imperial Discovery tour" tour, including the Ringstrasse, the Vienna State Opera House, the Museum Quarter and more. In the afternoon, venture to Schönbrunn Palace. Home to the Habsburg Royal family who ruled the Austro-Hungarian Empire, Vienna wears its historic wealth and grandeur on its sleeve. After a full day of exploration, enjoy a multicourse dinner on board.

DAY 13 | SLOVAKIA: BRATISLAVA

Awaken today in the capital city of Bratislava, Slovakia. Join the walking tour of Bratislava and see the home of the Slovak Philharmonic Orchestra, the old city walls, the summer residence of the archbishop and more. Later in the day, opt for an excursion to the Imperial Hof Palace in Austria, a magnificent 18th century complex once owned by Empress Maria Theresia. For those who enjoy wineries, choose the alternate scenic drive through the Little Carpathian mountain range with its winemaking tradition, dating back to Celtic and Roman times.

DAY 14 | HUNGARY: BUDAPEST

With its neo-Gothic Parliament, Fisherman's Bastion, Buda castle and Chain Bridge, the Hungarian capital of Budapest is a perfect finale to your trip. This morning, explore the sites of the Hungarian capital Budapest on a city tour. In the afternoon, food lovers can enjoy the alternate excursion for an authentic taste of Budapest, which starts at the market hall. Alternatively, roam further afield in Pest county to the Royal Palace of Gödöllő, one of the most important and imposing Hungarian palaces. On board this evening, celebrate at the Captain's Gala Dinner and enjoy a Hungarian folklore show as your vessel cruises the Danube to see this beautiful gem by night. Remain overnight in the "Queen of the Danube".

DAY 15 | BUDAPEST

After breakfast, the entire AMADEUS crew bids you farewell and wishes you a safe journey home.

Cruise fares per person in EUR based on double occupancy of a cabin

TOUR DATE	VESSEL	CABIN TYPE & DECKS					
		C-4 Haydn	C-1 Haydn	B-4 Strauss	B-1 Strauss	A-1 Mozart	Suite Mozart
15 days Amsterdam – Budapest							
09.05. – 23.05.	AMADEUS Riva	3.849	4.539	5.289	5.749	6.319	7.469
27.07. – 10.08.	AMADEUS Cara	3.659	4.309	5.019	5.459	5.999	7.099

Early booking discount of 15% on the above-mentioned prices when booked by **Nov 30, 2023**.

Single cabin supplement per person for all dates:

C-4+C-1: 15%, B-4: 30%, B-1: 50%, A-1: 60%, Suite: 100% of cruise price

For cruise price inclusions, see page 16, for deck plans see page 118–131.

Excursion packages prices per person in EUR and if booked in advance

Cruise Amsterdam – Budapest	UP	A	B	C	D
Amsterdam with canal trip and Holland Waterland	78	●	●	●	●
Cologne walking tour and Kölsch tasting	44	●	●	●	●
Siebengebirge and Drachenfels castle ruins	81				●
Rüdesheim with Music Cabinet Museum or Rüdesheim wine tasting & Drosselgasse	33 50		●		●
Miltenberg and Wertheim with glass museum	48	●	●		●
Würzburg walking tour with Residence & wine tasting or Medieval Rothenburg ob der Tauber	69 65		●		●
Bamberg walking tour	34	●	●	●	●
Nuremberg – capital of Franconia	52	●		●	●
Visit to the World of Gingerbread or The Documentation Center of Nuremberg	47 64		●		●
Regensburg walking tour or Thurn & Taxis Palace, brewery with tasting	24 76		●		●
Passau walking tour	24	●	●	●	●
Melk Abbey – A Baroque Jewel	61	●		●	●
Dürnstein walking tour with wine tasting	33		●		●
"Sound of Vienna" classical concert (cat. B)	73			●	●
Vienna – Imperial discovery tour	46	●	●	●	●
Visit to Schönbrunn Palace	67			●	●
Bratislava – Beauty on the Danube	45	●	●	●	●
Schloss Hof – Baroque Palace and Estate or The Little Carpathian Wine Route	67 61			●	●
Budapest – Castle Hill & Historic Wonders	45	●	●	●	●
An Authentic Taste of Budapest or Visit to the Royal Palace of Gödöllő	48 59			●	●
Excursion packages with 15% discount*		405	485	776	890

*compared to the unit price (UP) on board.

Package A with 10 excursions, Package B with 13 excursions, Package C with 17 excursions and Package D with 20 excursions.

Please refer to pages 132 – 147 for specific shore excursion details.

Transfers prices per person in EUR

Amsterdam: train station – vessel	50
Amsterdam: airport – vessel	59
Budapest: vessel – train station	31
Budapest: vessel – airport	55

Danube · Danube Delta

Classical Danube 58 – 63

8 days Budapest – Passau or Passau – Budapest

Danube Rhapsody 64 – 67

8 days Passau – Budapest – Passau

Blue Danube 68 – 71

8 days Nuremberg – Budapest

**Beautiful Blue Danube
and Danube Delta** 72 – 75

16 days Passau – Danube Delta – Passau

**1,200 Miles on the
Beautiful Blue Danube** 76 – 81

10 days Vienna – Danube Delta – Bucharest or

11 days Bucharest – Danube Delta – Vienna

Classical Danube

8 days | Budapest – Passau or Passau – Budapest

15%
Early Booking
Discount

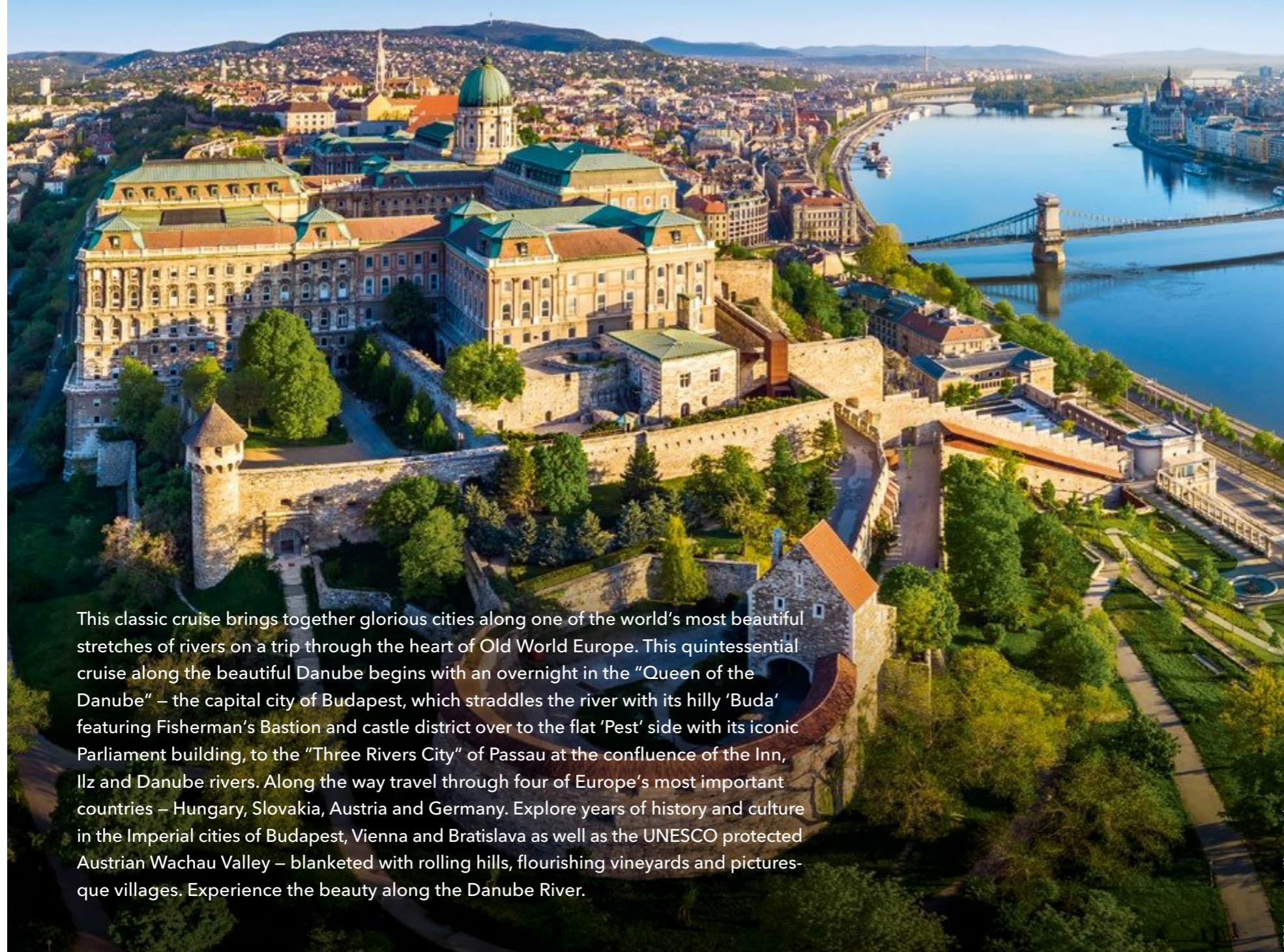

This classic cruise brings together glorious cities along one of the world's most beautiful stretches of rivers on a trip through the heart of Old World Europe. This quintessential cruise along the beautiful Danube begins with an overnight in the "Queen of the Danube" – the capital city of Budapest, which straddles the river with its hilly 'Buda' featuring Fisherman's Bastion and castle district over to the flat 'Pest' side with its iconic Parliament building, to the "Three Rivers City" of Passau at the confluence of the Inn, Ilz and Danube rivers. Along the way travel through four of Europe's most important countries – Hungary, Slovakia, Austria and Germany. Explore years of history and culture in the Imperial cities of Budapest, Vienna and Bratislava as well as the UNESCO protected Austrian Wachau Valley – blanketed with rolling hills, flourishing vineyards and picturesque villages. Experience the beauty along the Danube River.

Your itinerary

BUDAPEST – PASSAU

DAY/PORT	ARR	DEP	HIGHLIGHTS OF THE PROGRAM
1 Budapest			Embarkation from 4 pm Welcome Cocktail and Welcome Dinner Evening cruise Budapest with folklore show on board
2 Budapest		13:30	• Budapest – Castle Hill & Historic Wonders • Szentendre, Visegrád castle and Esztergom
Esztergom	18:30	20:00	Rejoin the ship
3 Bratislava	08:00	23:00	• Bratislava – Beauty on the Danube • Schloss Hof – Baroque Palace and Estate
4 Vienna	07:00	23:59	• Vienna – Imperial discovery tour • Visit to Schönbrunn Palace • "Sound of Vienna" classical concert (cat. B)
5 Dürnstein	08:00	12:00	• Dürnstein walking tour & Abbey • Winzer Krems – Vineyard and winery
Emmersdorf	15:00	19:00	• Melk Abbey – A Baroque Jewel
6 Linz	07:00	08:30	• Linz walking tour with Linzer Torte tasting
Aschach	11:00	11:30	• Full-day Salzburg with lunch
Passau	17:00	18:30	• Passau walking tour** Captain's Gala Dinner
7 Regensburg	10:00	20:00	• Regensburg walking tour • Danube Gorge, Weltenburg Abbey & beer tasting • Thurn & Taxis Palace, brewery with tasting Bavarian evening with regional specialities and local music on board
8 Passau	08:00		Disembarkation after breakfast

Excursions listed in blue are not included in the cruise price.

**not bookable together with the Full-day Salzburg with lunch. Please refer to pages 132 – 147 for specific shore excursion details.

We reserve the right to make amendments to the timetable and program.

For the Passau – Budapest itinerary, see page 62.

Price per person in double cabin from **1.639,-**€





Located in Lower Austria, Weissenkirchen in der Wachau is home to an impressive selection of attractions and experiences

Your day program Cruise Budapest–Passau

DAY 1 | HUNGARY: BUDAPEST

Your journey starts in Budapest. This evening, join us for a Welcome Cocktail, followed by a specially-prepared Welcome Dinner. A romantic evening cruise through beautifully illuminated Budapest, as well as a Hungarian folklore show, make for a perfect beginning!

DAY 2 | BUDAPEST · ESZTERGOM

Discover the beautiful sights and attractions of Budapest. This morning, explore the city which straddles the Danube, with its Fisherman's Bastion on the Buda side, overlooking the river, and the Pest side with its grand, Neo Gothic style Parliament House. Depart from Budapest after lunch by coach on an excursion to the Hungarian countryside to explore the artists' town of Szentendre, and the former capital of Hungary, Esztergom. Should you choose to remain on board, enjoy an afternoon relaxing on deck, before arriving in Esztergom for dinner, where your fellow passengers rejoin the vessel.

DAY 3 | SLOVAKIA: BRATISLAVA

In the morning, we call at our next capital city – Bratislava. Explore the city during a walking tour, or on your own. See the home of the Slovak Philharmonic Orchestra, the old city walls, the summer residence of the archbishop and the current residence of the

president of Slovakia. Just a stone's throw away from Bratislava lies a true gem of Baroque architecture – Schloss Hof. This afternoon, take the opportunity to step into a bygone era of opulence and grandeur and visit its aristocratic palace, terraced gardens and tranquil estate farm that seems to have sprung from the pages of a fairytale. Enjoy dinner on board before the vessel departs from Slovakia late this evening.

DAY 4 | AUSTRIA: VIENNA

There is much to see in Imperial Vienna: Palaces, a Museum Quarter displaying works by artists Egon Schiele and Gustav Klimt, the

historic buildings along the Ringstrasse, St. Stephen's Cathedral and the famous Vienna State Opera among others. This afternoon, choose to venture to Schönbrunn Palace, the sumptuous summer palace and gardens of Empress Maria Theresia and the Habsburg Empire. This evening take the chance to attend the "Sound of Vienna" and listen to the "Alt Vienna" orchestra play popular pieces from Vienna's classical era – a perfect end to your Vienna experience.

DAY 5 | DÜRNSTEIN · EMMERSDORF

The romantic Wachau Valley is one of the most beautiful landscapes of Austria. In the morning your ship docks in Dürnstein, with its blue medieval abbey on the edge of the Danube river. Wander through this quaint

Vienna: From the south tower of St. Stephen's Cathedral you can enjoy a wide panoramic view



"The evening cruise through Budapest with the illuminated Parliament was the crowning glory of the trip."

Elijah N.

village or join a walking tour featuring a visit to the Dürnstein Abbey. Alternatively, if you wish to explore the wines of the Wachau, a visit to the Krems winery estate to learn about the history and enjoy a tasting is a must. During lunch on board, your cruise continues to Emmersdorf. Spend the afternoon discovering this typical small town in Lower Austria or opt to travel across the river to nearby Melk and its glorious Benedictine abbey – the largest in Austria. In the evening, your ship leaves the Wachau and heads for Linz.

DAY 6 | LINZ · ASCHACH GERMANY: PASSAU

Arrive in the erstwhile cultural capital of Linz, where your vessel makes a short stop for the departure of today's excursions – the walking tour of Linz with a scenic drive to Aschach to rejoin the vessel for lunch, or a full day tour to the Mozart town of Salzburg with lunch at a local restaurant. Late in the afternoon, the ship arrives at the confluence of the Danube, the Inn and the Ilz Rivers, in the three-rivers city of Passau, which you can explore on a commented walking tour. This evening, celebrate at the Captain's Gala Dinner.

DAY 7 | REGENSBURG

After a leisurely breakfast, arrive in Regensburg, which is one of the most beautiful old towns in Germany. This UNESCO World Heritage Site boasts architecture from many centuries, reflective of its varied history. The stone bridge, built in 1135–1146 and the Cathedral of St. Peter are a few of the highlights seen on the guided walking tour. This afternoon, offers two options – an excursion to the Danube Gorge and Weltenburg Abbey or a visit to the Thurn and Taxis Palace – both excursions offer the opportunity to sample the local brew. A traditional Bavarian dinner is served as your ship departs.

DAY 8 | PASSAU

After breakfast, we bid you farewell.

A visit to the baroque jewel Melk Abbey



Cruise fares per person in EUR based on double occupancy of a cabin

TOUR DATE	VESSEL	CABIN TYPE & DECKS					
		C-4 Haydn	C-1 Haydn	B-4 Strauss	B-1 Strauss	A-1 Mozart	Suite Mozart
8 days Budapest – Passau							
21.05. – 28.05.	AMADEUS Imperial	2.079	2.399	2.799	3.049	3.359	3.969
07.07. – 14.07.	AMADEUS Riva	2.079	2.399	2.799	3.049	3.359	3.969
10.08. – 17.08.	AMADEUS Cara	1.969	2.289	2.669	2.899	3.189	3.769
16.10. – 23.10.	AMADEUS Riva	1.969	2.289	2.669	2.899	3.189	3.769
16.10. – 23.10.	AMADEUS Riva	2.079	2.399	2.799	3.049	3.359	3.969
8 days Passau – Budapest							
09.04. – 16.04.	AMADEUS Silver III	1.639	1.899	2.219	2.419	2.659	3.139
04.06. – 11.06.	AMADEUS Imperial	2.079	2.399	2.799	3.049	3.359	3.969
06.07. – 13.07.	AMADEUS Nova	2.079	2.399	2.799	3.049	3.359	3.969
21.08. – 28.08.	AMADEUS Riva	2.079	2.399	2.799	3.049	3.359	3.969
09.10. – 16.10.	AMADEUS Riva	2.079	2.399	2.799	3.049	3.359	3.969

Early booking discount of 15% on the above-mentioned prices when booked by Nov 30, 2023.

This cruise departure is also bookable as golf cruise, page 96.

Single cabin supplement per person for all dates:

C-4+C-1: 15%, B-4: 30%, B-1: 50%, A-1: 60%, Suite: 100% of cruise price.

For cruise price inclusions, see page 16, for deck plans see page 118–131.

Excursion packages prices per person in EUR and if booked in advance

Cruise Budapest – Passau	UP	A	B	C
Budapest – Castle Hill & Historic Wonders	45	●	●	●
Szentendre, Visegrád castle and Esztergom	58			●
Bratislava – Beauty on the Danube	45	●	●	●
Schloss Hof – Baroque Palace and Estate	67			●
Vienna – Imperial discovery tour	46	●	●	●
Visit to Schönbrunn Palace	67			●
"Sound of Vienna" classical concert (cat. B)	73		●	●
Dürnstein walking tour & Abbey	33		●	
or Winzer Krems – Vineyard and winery	53			●
Melk Abbey – A Baroque Jewel	61	●	●	●
Linz walking tour with Linzer Torte tasting (from Linz/to Aschach)	42		●	
or Full-day Salzburg with lunch	125			●
Passau walking tour**	24		●	
Regensburg walking tour	24	●	●	●
Danube Gorge, Weltenburg Abbey & beer tasting	78			●
or Thurn & Taxis Palace, brewery with tasting	76		●	
Excursion packages with 15% discount*		188	399	631

*compared to the unit price (UP) on board.

Package A incl. 5 excursions, Package B incl. 10 excursions and Package C incl. 12 excursions. Please refer to pages 132–147 for specific shore excursion details.

**not bookable together with the Full-day Salzburg with lunch.

For the Passau – Budapest itinerary:

The excursion „Linz walking tour with Linzer Torte tasting“ from/to embarkation port Linz – not bookable together with „Full-day Salzburg with lunch“ – and the unit price on board EUR 27,-. The price for the excursion package B if booked in advance EUR 386,-.

Transfers prices per person in EUR

Budapest: train station – vessel or v.v.	31
Budapest: airport – vessel or v.v.	55
Passau: vessel – train station or v.v.	28
Passau: vessel – Munich airport or v.v.	109

Your itinerary

PASSAU – BUDAPEST

DAY/PORT	ARR	DEP	HIGHLIGHTS OF THE PROGRAM
1 Passau		18:00	Embarkation from 4 pm Welcome Cocktail and Welcome Dinner
2 Regensburg	09:30	20:00	<ul style="list-style-type: none"> • Regensburg walking tour • Danube Gorge, Weltenburg Abbey & beer tasting or Thurn & Taxis Palace, brewery with tasting Bavarian evening with regional specialities and local music on board
3 Passau	08:00	10:00	<ul style="list-style-type: none"> • Passau walking tour or Full-day Salzburg with lunch Rejoin the ship
Linz	16:30	22:00	<ul style="list-style-type: none"> • Linz walking tour with Linzer Torte tasting**
4 Emmersdorf	08:00	12:00	<ul style="list-style-type: none"> • Melk Abbey – A Baroque Jewel Scenic cruising through the Wachau Valley
Dürnstein	14:00	17:30	<ul style="list-style-type: none"> • Dürnstein walking tour & Abbey or Winzer Krems – Vineyard and winery
Vienna		22:00	
5 Vienna		23:59	<ul style="list-style-type: none"> • Vienna – Imperial discovery tour • Visit to Schönbrunn Palace • “Sound of Vienna” classical concert (cat. B)
6 Bratislava	08:00	22:00	<ul style="list-style-type: none"> • Bratislava – Beauty on the Danube • Schloss Hof – Baroque Palace and Estate
7 Esztergom Budapest	07:00 13:00	08:30	<ul style="list-style-type: none"> • Esztergom, Visegrád castle and Szentendre Rejoin the ship • Budapest – Castle Hill & Historic Wonders Captain’s Gala Dinner Evening cruise Budapest with folklore show on board
8 Budapest			Disembarkation after breakfast

Excursions listed in blue are not included in the cruise price.

**not bookable together with the Full-day Salzburg with lunch. Please refer to pages 132 – 147 for specific shore excursion details. We reserve the right to make amendments to the timetable and program.

For cruise fares and excursion packages, see page 61.

Salzburg: The bastion Hohensalzburg rises above the roofs of the old baroque city.



Your day program

DAY 1 | GERMANY: PASSAU

This afternoon, embark and settle in your cabin. This evening, meet fellow travelers at a Welcome Cocktail, followed by a culinary prepared Welcome Dinner.

DAY 2 | REGENSBURG

This morning, your vessel arrives in one of Germany’s best-preserved medieval cities. On the morning tour, immerse yourself in the historic atmosphere of the town, which boasts architecture from many different centuries and a 12th century bridge. In the afternoon, choose between a visit to the 600-year-old Weltenburg Abbey, which is situated on the banks of the Danube and houses the oldest monastic brewery in the world, and a trip to the 18th century Thurn and Taxis Palace with beer tasting at their traditional brewery. This evening, enjoy a special Bavarian theme on board with regional delicacies and live music.

DAY 3 | PASSAU · AUSTRIA: LINZ

The vessel returns this morning for a short stop at the three-rivers city of Passau, lying at the confluence of the Danube, the Inn and the Ilz. In the morning, take a guided walking excursion. At St. Stephen’s Cathedral, see an organ with 17,774 pipes and 233 registers, the second largest in the world. Passau is also the starting point for the full day excursion to Salzburg with lunch at a local restaurant. For those remaining on board, relax on the Sun Deck and take in the scenery as the vessel moves toward its late afternoon visit to Linz. Join the walking tour and stroll on streets squares boasting unique churches, concert

venues, and plenty of artists who come to the city to thrive. Before returning to the vessel, sample perhaps the famous Linzer Torte.

DAY 4 | EMMERSDORF · DÜRNSTEIN · VIENNA

Set on a rocky outcrop overlooking the Danube, the Baroque Benedictine abbey of Melk awaits you this morning with its frescoes created by pre-eminent artists of the 18th century, and a magnificent library with priceless manuscripts.

During lunch on board, the ship continues to Dürnstein, a picturesque wine growers’ village located in the heart of the UNESCO World Heritage Site of the Wachau Valley. Explore the village with a local guide or choose an excursion to a local vineyard to sample some of the region’s famous Grüner Veltliner wines. The ship arrives in Vienna later this evening and remains overnight.

Relax with a glass of wine and enjoy the panorama on the shore



DAY 5 | VIENNA

There is much to see in Vienna: its imperial palaces, the Museum Quarter displaying works by Egon Schiele, Gustav Klimt and other artists, the impressive buildings along the

“This was my first river cruise and I loved it! The Danube is now one of my big travel highlights.”

Michelle L.

“Ringstrasse”, St. Stephen’s Cathedral and the famous Vienna State Opera among many others. This afternoon, perhaps venture to Schönbrunn Palace, the sumptuous summer palace and gardens of Empress Maria Theresa and the Habsburg Empire. Cap off your Vienna experience with a “Sound of Vienna” concert in a local hall. Listen to the “Alt Vienna” orchestra play popular pieces

from Vienna’s classical era. The vessel remains in Vienna until late this evening when it departs for Bratislava.

DAY 6 | SLOVAKIA: BRATISLAVA

Wake up this morning in Bratislava, a jewel on the Danube and the capital of Slovakia. Explore the city on your own or with a guided optional tour through the city. See the home of the Slovak Philharmonic Orchestra, the old city walls, the summer residence of the archbishop and the current residence of the president of Slovakia. This afternoon you can choose to travel outside the city to the Schloss Hof Palace and Estate – the Imperial country estate of the Habsburgs acquired by the Empress Maria Theresa.

DAY 7 | HUNGARY: ESZTERGOM · BUDAPEST

Relax on board as the vessel makes its way to Budapest, Hungary. For those interested in exploring the Hungarian countryside, the optional excursion departs in Esztergom, with its basilica dedicated to Saint Mary, and continues to Szentendre, known for its art galleries and museums. Rejoin your vessel after it docks in Budapest in time for lunch.

This afternoon, explore the fantastic Hungarian capital of Budapest on a panoramic tour. The unique Chain Bridge straddles the Danube, connecting the Buda side and its Fisherman’s Bastion, with the Pest side and its iconic Hungarian Parliament building. On your last evening on board, the festive Captain’s Gala Dinner and a lights cruise through the magnificently illuminated metropolis, accompanied by a spirited folklore performance, await you.

DAY 8 | BUDAPEST

After breakfast, the entire AMADEUS crew bids you farewell and wishes you a safe journey home.

Danube Rhapsody

8 days | Passau – Budapest – Passau

15%
Early Booking
Discount



Journey to the heart of the once-illustrious Habsburg monarchy, along the fabled Danube River. Explore the art and culture of historic Europe as your vessel travels through four countries filled with spectacular scenery. Visit three world-famous capital cities, classical music of Mozart, Strauss, Bartok and Schmidt. Impressive architecture, the natural beauty of the UNESCO protected Wachau Valley along with the flavors of the "Linzer Torte", "Sacher Torte" and Austrian wines are just a few of the highlights of this trip.

Your itinerary

DAY/PORT	ARR	DEP	HIGHLIGHTS OF THE PROGRAM
1 Passau		17:00	Embarkation from 4 pm Welcome Cocktail and Welcome Dinner
2 Emmersdorf	09:00	11:30	<ul style="list-style-type: none"> • Melk Abbey – A Baroque Jewel • Dürnstein walking tour with wine tasting • Exclusive private concert on board
Dürnstein	13:30	16:00	
Vienna	21:00		
3 Vienna		19:00	<ul style="list-style-type: none"> • Vienna – Imperial discovery tour • Visit to Schönbrunn Palace
4 Budapest	11:30		<ul style="list-style-type: none"> • Budapest – Castle Hill & Historic Wonders • Evening cruise Budapest with folklore show on board
5 Budapest		13:30	<ul style="list-style-type: none"> • Traditions of the Hungarian Puszta or An Authentic Taste of Budapest • Szentendre, Visegrád castle and Esztergom • Rejoin the ship
Esztergom	19:00	19:15	
6 Bratislava	08:00	14:00	<ul style="list-style-type: none"> • Bratislava – Beauty on the Danube • Schloss Hof – Baroque Palace and Estate • Rejoin the ship
Hainburg	16:00	16:30	
7 Linz	14:00	22:00	<ul style="list-style-type: none"> • Linz walking tour with Linzer Torte tasting or Trip to the Pöstlingberg • Captain's Gala Dinner
8 Passau	07:30		Disembarkation after breakfast

Excursions listed in blue are not included in the cruise price. Please refer to pages 132 – 147 for specific shore excursion details. We reserve the right to make amendments to the timetable and program.

Price per person in double cabin from **1.639,-**€





One of the most popular sights: the Esztergom Basilica, Hungary's largest house of worship

Your day program Cruise Passau – Budapest – Passau

DAY 1 | GERMANY: PASSAU

Beautiful Passau is the starting point for your memorable Danube cruise. After embarkation, meet your fellow travelers at a Welcome Cocktail and Welcome Dinner.

DAY 2 | AUSTRIA: EMMERSDORF · DÜRNSTEIN · VIENNA

This morning presents an opportunity to visit the eye-catching Baroque Benedictine abbey of Melk. This Baroque jewel is filled with interior frescoes created by preeminent artists of the 18th century, and a magnificent library with priceless manuscripts. During lunch on board, the ship continues to Dürnstein, a picturesque wine growers' village located in the heart of the UNESCO World Heritage Site of the Wachau Valley. Explore the village on a guided tour or choose to sample some of the region's famous "Grüner Veltliner" wines during an excursion to a local vineyard. After departure, enjoy dinner and an exclusive private concert onboard. The ship arrives in Vienna later this evening and remains overnight.

DAY 3 | VIENNA

There is much to see and do in this Imperial capital city. A panoramic tour rewards you with views of the "Ringstrasse" with its pompous buildings, the famous State Opera House, the Museum Quarter with historic and contemporary architecture and St. Stephen's Cathedral. In the afternoon, continue your exploration or venture with the group to Schönbrunn Palace, the sumptuous former summer palace and gardens of Empress Maria Theresia. Be sure

to explore the elegant Gloriette, a stunning hilltop pavilion offering panoramic views of the palace and Vienna's skyline. After a full day of adventures, enjoy dinner on board as the vessel departs.

DAY 4 | HUNGARY: BUDAPEST

After a relaxing morning on board, arrive in Budapest shortly before lunch. Spend the afternoon in this capital city, which uniquely straddles the Danube River. A large portion of this city is a World Heritage Site, including the banks of the Danube, the Buda castle quarter, Heroes' Square, and the Millennium

Underground Railway. With 80 geothermal hot springs, the third largest parliament building in the world, and the second largest synagogue, there is truly something for everyone to enjoy in this bustling metropolis. As a special treat this evening, local artists come on board to entertain with dances and music, as the vessel cruises the Danube through this iconic city by night. Remain overnight.

DAY 5 | BUDAPEST · ESZTERGOM

This morning offers time to discover more of Budapest or an opportunity to explore rural Hungary with a visit to the "Puszta" or countryside. Food lovers can enjoy the alternative excursion "An Authentic Taste of Budapest" which starts at the market hall.

AMADEUS ship in front of Dürnstein, the „Pearl of the Wachau“.



Admire Budapest's famous thermal baths and, finally, visit one of Budapest's numerous pastry shops, where you can order delicious cakes and pastry. The vessel departs from Budapest shortly after lunch and continues to Slovakia. Relax on board or join the optional excursion to visit Szentendre, an artists' village with art museums and galleries, and Esztergom, the seat of the Hungarian Catholic church and former capital city. Those on the excursion rejoin the vessel in Esztergom before dinner. Watch the receding lights of the city as the vessel continues on its way.

DAY 6 | SLOVAKIA: BRATISLAVA · AUSTRIA: HAINBURG

Wake up in the capital city of Bratislava, Slovakia. Join the walking tour and see the home of the Slovak Philharmonic Orchestra, the old city walls, the summer residence of the archbishop and more. After lunch, choose to visit the Imperial Schloss Hof Palace, once owned by Empress Maria Theresia. The palace, gardens and farm seem to have sprung from the pages of a fairytale. Rejoin the vessel in Hainburg.

DAY 7 | LINZ

After lunch you will arrive in Linz, the third largest city in Austria. See the Mozarthaus and the Renaissance villas here, along with the main street and square, which boast unique churches and concert venues. Alternatively, a tour on the Pöstlingberg narrow gauge train or 'mountain tramway' awaits. After the ride to the summit, take a walk to the church "Seven Sorrows of Virgin Mary". Don't miss the popular observation terrace providing magnificent views of Linz and the surrounding countryside. Later today, join us in the Panorama-Restaurant for an evening of glamour, great company, incredible food and wines at the Captain's Gala Dinner.

DAY 8 | GERMANY: PASSAU

After breakfast, we bid you farewell.

Budapest: the Chain bridge



Cruise fares per person in EUR based on double occupancy of a cabin

TOUR DATE	VESSEL	CABIN TYPE & DECKS					
		C-4* Haydn	C-1 Haydn	B-4 Strauss	B-1 Strauss	A-1 Mozart	Suite Mozart
8 days Passau – Budapest – Passau							
02.04. – 09.04.	AMADEUS Silver III	1.639	1.909	2.219	2.419	2.659	3.139
07.06. – 14.06.	AMADEUS Riva	2.079	2.399	2.799	3.049	3.359	3.969
15.06. – 22.06.	AMADEUS Nova	2.079	2.399	2.799	3.049	3.359	3.969
14.07. – 21.07.	AMADEUS Riva	1.969	2.289	2.669	2.899	3.189	3.769
21.07. – 28.07.	AMADEUS Riva	1.969	2.289	2.669	2.899	3.189	3.769
30.07. – 06.08.	AMADEUS Brilliant	1.769	2.059	2.399	2.609	2.869	3.389
22.08. – 29.08.	AMADEUS Nova	2.079	2.399	2.799	3.049	3.359	3.969
12.09. – 19.09.	AMADEUS Nova	2.079	2.399	2.799	3.049	3.359	3.969
26.09. – 03.10.	AMADEUS Queen	2.079	2.399	2.799	3.049	3.359	3.969
02.10. – 07.10.	AMADEUS Riva	2.079	2.399	2.799	3.049	3.359	3.969
12.10. – 19.10.	AMADEUS Brilliant	1.769	2.059	2.399	2.609	2.869	3.389

Early booking discount of 15% on the above-mentioned prices when booked by **Nov 30, 2023**. Single cabin supplement per person for all dates: C-4 + C-1: 15%, B-4: 30%, B-1: 50%, A-1: 60%, Suite: 100% of cruise price. *True single cabins with no single supplement available on *AMADEUS Brilliant* at the price of C-4 cabins.

For cruise price inclusions, see page 16, for deck plans see page 118–131.

Excursion packages prices per person in EUR and if booked in advance

Cruise Passau – Budapest – Passau	UP	A	B	C
Melk Abbey – A Baroque Jewel	61	●	●	●
Dürnstein walking tour with wine tasting	33		●	●
Vienna – Imperial discovery tour	46	●	●	●
Visit to Schönbrunn Palace	67			●
Budapest – Castle Hill & Historic Wonders	45	●	●	●
Traditions of the Hungarian Puszta (from/to Budapest)	81	●		●
or An Authentic Taste of Budapest	48		●	
Szentendre, Visegrád castle and Esztergom	58		●	●
Bratislava – Beauty on the Danube	45	●	●	●
Schloss Hof – Baroque Palace and Estate	67			●
Linz walking tour with Linzer Torte tasting	27	●		●
or Trip to the Pöstlingberg	35		●	
Excursion packages with 15% discount*		259	315	451

*compared to the unit price (UP) on board. Package A incl. 6 excursions, Package B incl. 8 excursions and Package C incl. 10 excursions. Please refer to pages 132–147 for specific shore excursion details.

Transfers prices per person in EUR

Passau: train station – vessel or v.v.	28
Munich airport – vessel/Passau or v.v.	109

Parking place prices in EUR

Passau: 8 days outdoor parking	98
Passau: 8 days indoor garage	117

Blue Danube

8 days | Nuremberg – Budapest

15%
Early Booking
Discount



Travel through Europe on a journey between two magnificent Old World Capitals: Nuremberg, heart of the German Renaissance in the 15th and 16th centuries and Budapest Hungary, with its classic good looks, beautiful streets and many thermal spas. Travel east on the Danube River while soaking in the magic of Bavaria, the beauty of the Wachau Valley, stately Imperial Vienna, the charm of Bratislava and the openness of the Hungarian countryside on the way to the finale – the pearl of the Danube – Budapest. You'll discover an abundance of historical and cultural riches along the waterway of the Blue Danube.

© WGD Danau OÖ Tourismus GmbH/Steininger

Your itinerary

DAY/PORT	ARR	DEP	HIGHLIGHTS OF THE PROGRAM
1 Nuremberg		17:00	Embarkation from 4 pm Welcome Cocktail and Welcome Dinner
2 Regensburg	13:00	22:00	<ul style="list-style-type: none"> • Regensburg walking tour or Thurn & Taxis Palace, brewery with tasting Bavarian evening with regional specialties and local music on board
3 Passau	12:00	16:00	<ul style="list-style-type: none"> • Passau walking tour Panoramic passage of the Schlögener Schlinge
4 Emmersdorf	06:30	11:30	<ul style="list-style-type: none"> • Melk Abbey – A Baroque Jewel Scenic cruising throught the Wachau Valley
Dürnstein	13:00	15:00	<ul style="list-style-type: none"> • Dürnstein walking tour with wine tasting
Vienna	19:15	23:59	<ul style="list-style-type: none"> • “Sound of Vienna” classical concert (cat. B)
5 Vienna		23:59	<ul style="list-style-type: none"> • Vienna – Imperial discovery tour • Visit to Schönbrunn Palace
6 Bratislava	07:00	20:00	<ul style="list-style-type: none"> • Bratislava – Beauty on the Danube • Schloss Hof – Baroque Palace and Estate or The Little Carpathian Wine Route
7 Budapest	08:30		<ul style="list-style-type: none"> • Budapest – Castle Hill & Historic Wonders • An Authentic Taste of Budapest or Visit to the Royal Palace of Gödöllő Captain's Gala Dinner Evening cruise Budapest with folklore show on board
8 Budapest			Disembarkation after breakfast

Excursions listed in blue are not included in the cruise price.
Please refer to pages 132 – 147 for specific shore excursion details.
We reserve the right to make amendments to the timetable and program.

Price per person in double cabin from **2.069,-**€



The Schlögener Schlinge between Passau and Aschach is a 180° bend of the Danube in the breakthrough valley through the Bohemian Massif.

DANUBE · MAIN-DANUBE CANAL

DANUBE · MAIN-DANUBE CANAL



Austria's largest Baroque monastery and UNESCO World Heritage Site: Melk Abbey in the Wachau Valley

Your day program Cruise Nuremberg – Budapest

DAY 1 | GERMANY: NUREMBERG

Begin your European cruise with embarkation in the Bavarian town of Nuremberg. After an evening Welcome Cocktail, our chef will treat you to a specially-prepared Welcome Dinner – a wonderful start to this unforgettable trip.

DAY 2 | REGENSBURG

Regensburg is one of Germany's best-preserved medieval cities. Choose to uncover the secrets of this remarkable UNESCO Site during a walking tour this afternoon. Alternatively, visit the 18th century Thurn and Taxis Palace for a beer tasting in their traditional brewery. A special Bavarian themed evening celebrates this memorable region.

DAY 3 | PASSAU

Arrive in time for lunch in Passau, lying at the confluence of the Danube, the Inn and the Ilz Rivers. In the afternoon, join the city walking tour, which includes the most enchanting sights of this historic, hilly city including St. Stephen's Cathedral, home to one of the largest pipe organs in the world. Back on board, enjoy dinner as the vessel sets off toward the Wachau Valley, with its endless expanse of rolling hills, historic fortresses and romantic vineyards.

DAY 4 | AUSTRIA: EMMERSDORF · DÜRNSTEIN · VIENNA

In the early morning, dock in Emmersdorf, in the heart of the UNESCO-protected Wachau Valley. Spend the morning discovering this typical Austrian town or travel across the

river to Melk and its magnificent Benedictine abbey – the largest in Austria. Back on board for lunch, continue through the vineyards of the Wachau to the village of Dürnstein. Spend the afternoon in this romantic village with its iconic blue church and winding streets, and perhaps sample the local wines. After dinner, arrive in Vienna, the beautiful Austrian city with a rich history. In the evening, opt for the "Sound of Vienna" concert and listen to popular pieces from Vienna's classical era at a local salon. The vessel remains overnight.

Enjoy a stroll through the beautiful vineyards



"The many insider tips from our guides made the excursions so valuable."

Jeffrey D.

DAY 5 | VIENNA

There is much to see and do in this imperial capital city. Enjoy the sights of Vienna on the "Imperial Discovery tour" tour, including the Ringstrasse, the Vienna State Opera House, the Museum Quarter and more. In the afternoon, venture to Schönbrunn Palace, the sumptuous former summer palace of Empress Maria Theresia. After a full day of exploration, enjoy a relaxing dinner on board. Late in the evening your vessel sets course for Bratislava.

DAY 6 | SLOVAKIA: BRATISLAVA

Awaken today in the capital city of Slovakia. Join the walking tour of Bratislava and see the home of the Slovak Philharmonic Orchestra, the old city walls, the summer residence of the archbishop and more. Later in the day, choose the excursion to the Imperial Schloss Hof Palace in Austria, an impressive 18th century complex once owned by Empress Maria Theresia. The aristocratic palace, terraced gardens and tranquil estate farm seem to have sprung from the pages of a fairytale. Or, if you enjoy wineries, take a scenic drive through the Little Carpathian mountain range with its winemaking tradition dating back to Celtic and Roman times, making it one of the oldest wine-producing regions in Europe.

DAY 7 | HUNGARY: BUDAPEST

With its neo-Gothic Parliament, Fisherman's Bastion, Buda castle and Chain Bridge – Budapest is a perfect finish to your trip. This morning, explore the sites of the Hungarian capital on a city tour. In the afternoon, food lovers can enjoy the excursion "An Authentic Taste of Budapest" which starts at the market hall. Admire Budapest's famous thermal baths and, finally, make a stop at one of Budapest's numerous pastry shops, where you can order tasty Hungarian cakes and pastry. Alternatively, roam further afield to Pest county to immerse yourself in the opulence of the imperial lifestyle as you visit the Royal Palace of Gödöllő. On board this evening, enjoy the Captain's Gala Dinner and a Hungarian folklore show as your vessel cruises along Budapest's sparkling panorama with stunning views of the Parliament and the Citadel. Remain overnight in the "Queen of the Danube".

DAY 8 | BUDAPEST

After breakfast, the crew bids you farewell. We hope to welcome you again soon!

Sunset over the Danube near Bratislava



Cruise fares per person in EUR based on double occupancy of a cabin

TOUR DATE	VESSEL	CABIN TYPE & DECKS					
		C-4 Haydn	C-1 Haydn	B-4 Strauss	B-1 Strauss	A-1 Mozart	Suite Mozart
8 days Nuremberg – Budapest							
16.05. – 23.05.	AMADEUS Riva	2.179	2.529	2.949	3.199	3.559	3.999
03.08. – 10.08.	AMADEUS Cara	2.069	2.399	2.799	3.039	3.379	3.799

Early booking discount of 15% on the above-mentioned prices when booked by **Nov 30, 2023**.

Single cabin supplement per person for all dates:

C-4+C-1: 15%, B-4: 30%, B-1: 50%, A-1: 60%, Suite: 100% of cruise price.

For cruise price inclusions, see page 16, for deck plans see page 118–131.

Excursion packages prices per person in EUR and if booked in advance

Cruise Nuremberg – Budapest	UP	A	B	C
Regensburg walking tour	24		●	
or Thurn & Taxis Palace, brewery with tasting	76			●
Passau walking tour	24	●	●	●
Melk Abbey – A Baroque Jewel	61	●		●
Dürnstein walking tour with wine tasting	33			●
"Sound of Vienna" classical concert (cat. B)	73		●	●
Vienna – Imperial discovery tour	46	●	●	●
Visit to Schönbrunn Palace	67			●
Bratislava – Beauty on the Danube	45	●	●	●
Schloss Hof – Baroque Palace and Estate	67			●
or The Little Carpathian Wine Route	61		●	
Budapest – Castle Hill & Historic Wonders	45	●	●	●
An Authentic Taste of Budapest	48			●
or Visit to the Royal Palace of Gödöllő	59		●	
Excursion packages with 15% discount*		188	320	497

*compared to the unit price (UP) on board.

Package A incl. 5 excursions, Package B incl. 8 excursions and Package C incl. 11 excursions.

Please refer to pages 132 – 147 for specific shore excursion details.

Transfers prices per person in EUR

Nuremberg: train station – vessel	75
Nuremberg: airport – vessel	75
Budapest: vessel – train station	31
Budapest: vessel – airport	55

Beautiful Blue Danube and Danube Delta

16 days | Passau – Danube Delta – Passau

15%
Early Booking
Discount

Experience the full length of the Danube, the most beautiful river of Europe. Begin in Passau and cruise 4,000 river kilometers to kilometer zero of the Danube where it empties into the Black Sea. Visit eight countries (Germany, Austria, Hungary, Slovakia, Serbia, Croatia, Bulgaria and Romania), and five world-renowned capital cities (Vienna, Budapest, Bratislava, Belgrade and Bucharest). Experience the glorious beauty of the narrowest part of the Danube as it cruises through the "Iron Gates" which is a series of 4 gorges and basins which divide Serbia and Romania. This is the narrowest part of the Danube, which breaks through the mountains with the Carpathians on one side and the Balkans on the other. Couple this spectacular passage with the journey to the estuary of the Danube, where it meets the Black Sea, and the UNESCO protected site of the Danube Delta with its vast wildlife and natural beauty, for an unforgettable experience.

The UNESCO Danube Delta Biosphere Reserve is a refuge for Europe's largest colony of the pink pelican with a good 7,000 specimens.

Your itinerary

DAY/PORT	ARR	DEP	HIGHLIGHTS OF THE PROGRAM
1 Passau		18:00	Embarkation from 4 pm Welcome Cocktail and Welcome Dinner
2 Vienna	14:00	18:30	• Vienna – Imperial discovery tour
3 Esztergom Budapest	07:30 12:30	08:30 13:00	• Esztergom, Visegrád castle and Szentendre Rejoin the ship
4 Belgrade	13:30	19:00	• Dynamic Belgrade & Kalemegdan Fortress or Kovačica – Rural Serbia
5 Vidin	15:00	18:30	• Vidin walking tour or Excursion to the Baba Vida Fortress with concert
6 Oltenița Fetești	13:30 20:30	14:30 22:00	• Bucharest "Paris of the East" and dinner Rejoin the ship
7 Danube Delta			Cruise on the St. George branch to km 0 of the Danube and the Black Sea • Danube Delta nature experience
8 Hârșova Fetești	13:00 19:00	14:00 19:30	• Constanța archeology and Black Sea coast Rejoin the ship
9 Rousse	08:00	08:30	• Veliko Tarnovo – Cultural Capital of the Balkans or Rousse with Basarbovo Monastery
10 Iron Gates			Cruise day with passage of the famous Iron Gates
11 Novi Sad Vukovar	10:00 19:00	14:00 22:00	• Novi Sad and Sremski Karlovci • Vukovar evening walking tour
12 Mohács	08:00	14:00	• Visit to a 700 years old mill with oven pie tasting • Traditions of the Hungarian Puszta
13 Budapest	04:00	21:30	• Budapest – Castle Hill & Historic Wonders • Visit to the Royal Palace of Gödöllő or An Authentic Taste of Budapest Evening cruise Budapest with folklore show on board
14 Bratislava	15:00	19:00	• Bratislava – Beauty on the Danube
15 Dürnstein Emmersdorf	09:00 13:00	09:30 14:00	• Visit to Melk Abbey and walking tour in Melk or Winzer Krems – Vineyard and winery Rejoin the ship Captain's Gala Dinner
16 Passau	08:30		Disembarkation after breakfast

Excursions listed in blue are not included in the cruise price.
Please refer to pages 132 – 147 for specific shore excursion details.
We reserve the right to make amendments to the timetable and program.

Price per person in double cabin from **2.649,-€**





© Angyalosi Beata/Shutterstock.com

The small monastery of Mraconia, built in 1523, in the nature-protected valley of the "Iron Gate".

Your day program Cruise Passau – Danube Delta – Passau

DAY 1 | GERMANY: PASSAU

This afternoon, embark your vessel settle into your cabin. This evening, enjoy a Welcome Cocktail, followed by a specially prepared Welcome Dinner.

DAY 2 | AUSTRIA: VIENNA

Arrive in Vienna this afternoon where the sights of Imperial Vienna await. Spend time exploring this majestic city with its dynamic history on a city tour, before reboarding the vessel for dinner and departing for Hungary.

DAY 3 | HUNGARY: ESZTERGOM · BUDAPEST

Spend a relaxing day cruising the blue Danube or opt to join an excursion to Esztergom, the former residence of the Hungarian kings and Szentendre, an artists' colony with numerous contemporary galleries and museums. Just before lunch, the vessel stops to allow our guests on the optional shore excursion to rejoin, before continuing

DAY 4 | SERBIA: BELGRADE

During lunch, arrive in Belgrade, one of the oldest European cities and the capital of Serbia. The "White City" is one of the most historically rich and important in all of Serbia and boasts a large number of monuments from different times and cultures. Travel to the Kalemegdan fortress for a panoramic view over the Danube and the Sava Rivers. Take a stroll on the lively pedestrian area for shopping. Alternatively

"Cruising with the small excursion boats through the Danube Delta, while the pelicans fly overhead – a really special moment."

Kevin & Suzanna S.

join an excursion into the Serbian countryside to Kovačica's colorful naïve artist's village. Dinner this evening is on board as the vessel continues cruising.

DAY 5 | BULGARIA: VIDIN

Reach Bulgaria this afternoon and visit Vidin, a town renowned for its centuries of history. Join a walking tour through the streets and view the many churches and Renaissance buildings decorating the town. Or join an excursion to Belogradchik, located a short distance away, and visit the Baba Vida fortress for a concert. Located on the banks of the Danube, Baba Vida is the only fully-preserved medieval fortress in Bulgaria. Back on board for dinner, the vessel continues.

DAY 6 | ROMANIA: OLTENIȚA · FETEȘTI

Voilà: Do you feel French? That's because of our trip to the "Paris of the East." An optional excursion to Bucharest is offered for those wishing to explore this capital city, with dinner at a local restaurant, rejoining the vessel in Fetești. For those remaining on board, enjoy a relaxing day cruising the Danube River.

DAY 7 | DANUBE DELTA · ST. GEORGE

Wake up this morning as the vessel cruises to the Danube kilometer 0. At the meeting of the Black Sea and the Danube, this UNESCO-site hosts 27 different ecosystems and is home to many unique species of birds, fish, and other creatures. From the fisherman's village of St. George, observe the daily life of the people who inhabit this delta. For those wishing to delve further into the scenic waterways, the optional Danube Delta nature experience awaits. During dinner, enjoy sunset over the waters of the Danube Delta.

DAY 8 | HÂRȘOVA · FETEȘTI

Relaxation is on the schedule today as the vessel plies the waters of the Danube. The afternoon offers an opportunity to see Constanța, the oldest city on the Black Sea coast. This ancient metropolis by the sea is Romania's longest continually inhabited city. The vessel stops for those on the excursion to rejoin before dinner this evening.

DAY 9 | BULGARIA: ROUSSE · SVISHTOV

For a little more adventure today, opt to join the guided tour to Veliko Tarnovo, the oldest town in Bulgaria. This pretty town is located on the steep banks of the river Yantra. Alternatively, visit the city of Rousse and the only active cave monastery in Bulgaria, the rock-hewn Basarbovo Monastery, built in the 16th century approximately 115 feet above the river. Both excursions rejoin the vessel in Svishtov in time for lunch.

DAY 10 | IRON GATES

On deck there is much natural beauty to take in as your vessel makes its way through the river's narrowest points, known as the 'Iron Gates'. Watch from the Sun Deck as the vessel passes through the steep gorges between the Carpathian and Balkan Mountains which form the natural border between Serbia and Romania. Admire the largest sculpture on a riverbank: the face of Decebalus. The waterflow is controlled by two hydroelectric dams, jointly operated by Romania and Serbia, which create the largest reservoir system along the entire Danube.

DAY 11 | NOVI SAD · CROATIA: VUKOVAR

While approaching Novi Sad late this morning, view the symbol of the city on the right bank of the Danube, the famed Petrovaradin

fortress. Join the guided tour to take a closer look at this fortress that no enemy has ever taken and see the main sights of the 2022 European Capital of Culture.

Continue to Sremski Karlovci, a multiethnic town associated with wine, spirituality and poetry. This evening, the vessel stops in Vukovar, in Croatia, located on an important trade route at the confluence of the Vuka and Danube Rivers. Opt for an evening tour to explore this bustling city, before the vessel departs for the next port of call.

DAY 12 | HUNGARY: MOHÁCS · KALOCSA

The tiny harbor town of Mohács is a melting pot of nations. Join us on a morning visit to an over 700 years old watermill, one of the few where grinding is still performed by stones. Its collection of tools shows the evolution of grain processing from prehistoric to modern times. Taste a typical oven pie before returning to the ship. This afternoon, relax on board or join the optional excursion to the "Pusztá" where you will visit a horse ranch for a traditional equestrian show. Rejoin your vessel in Kalocsa in time for dinner.

DAY 13 | BUDAPEST

Early morning the vessel arrives in the Hungarian capital, Budapest. This morning, explore the sites of the town, on a city tour. In the afternoon, food lovers can enjoy the excursion "An Authentic Taste of Budapest" which starts at the market hall. Admire Budapest's famous geothermal baths and, finally, make a stop for delicious cakes and pastry. Alternatively, visit the Baroque Royal Palace of Gödöllő, one of the most important Hungarian palaces. After an exciting day of discovery, a special Hungarian evening is planned with traditional music topped with an evening cruise down the Danube.

DAY 14 | SLOVAKIA BRATISLAVA

New day, new capital – and just as worth discovering. On our tour you will follow the historical traces of the Habsburg monarchy. Afterwards we stroll through Bratislava's small, but very beautiful old town with its historical center.

DAY 15 | AUSTRIA: DÜRNSTEIN · EMMERSDORF

This morning, arrive in Dürnstein, a tiny village surrounded by vineyards, which serves as a starting point for an optional excursion to Melk and its magnificent Benedictine abbey. For those wishing to explore the artistry of Austrian winemaking a little more in depth, join the excursion to a Winzer Krems vineyard and winery. This afternoon, with all travelers safely back on board, the vessel cruises toward the port where this magnificent voyage began. This evening, enjoy the Captain's Gala Dinner.

DAY 16 | GERMANY: PASSAU

After breakfast, the AMADEUS crew bids you farewell and wishes you a safe journey home.

Cruise fares per person in EUR based on double occupancy of a cabin

TOUR DATE	VESSEL	CABIN TYPE & DECKS					
		C-4* Haydn	C-1 Haydn	B-4 Strauss	B-1 Strauss	A-1 Mozart	Suite Mozart
16 days Passau – Danube Delta – Passau							
23.04.–08.05.	AMADEUS Silver III	2.799	3.429	4.199	4.669	5.319	6.399
15.07.–30.07.	AMADEUS Brilliant	2.649	3.249	3.979	4.419	5.039	6.059
08.09.–23.09.	AMADEUS Cara	3.099	3.799	4.659	5.169	5.899	7.089
23.09.–08.10.	AMADEUS Cara	3.099	3.799	4.659	5.169	5.899	7.089

Early booking discount of 15% on the above-mentioned prices when booked by **Nov 30, 2023**. Single cabin supplement per person for all dates: C-4+C-1: 15%, B-4: 30%, B-1: 50%, A-1: 60%, Suite: 100% of cruise price. *True single cabins with no single supplement available on AMADEUS Brilliant at the price of C-4 cabins.

For cruise price inclusions, see page 16, **for deck plans** see page 118–131.

Excursion packages prices per person in EUR and if booked in advance

Cruise Passau – Danube Delta – Passau	UP	A	B	C
Vienna – Imperial discovery tour	46	●	●	●
Esztergom, Visegrád castle and Szentendre	58		●	●
Dynamic Belgrade & Kalemegdan Fortress or Kovačica – Rural Serbia	46 34	●	●	●
Vidin walking tour or Excursion to the Baba Vida Fortress with concert	23 54		●	●
Bucharest "Paris of the East" and dinner	109	●	●	●
Danube Delta nature experience	64	●	●	●
Constanța archeology and Black Sea coast	67		●	●
Veliko Tarnovo – Cultural Capital of the Balkans or Rousse with Basarbovo Monastery	68 66		●	●
Novi Sad and Sremski Karlovci	46		●	●
Vukovar evening walking tour	33			●
Visit to a 700 years old mill with oven pie tasting	55			●
Traditions of the Hungarian Pusztá (from Mohács/to Kalocsa)	81	●		●
Budapest – Castle Hill & Historic Wonders	45	●	●	●
Visit to the Royal Palace of Gödöllő or An Authentic Taste of Budapest	59 48		●	●
Bratislava – Beauty on the Danube	45	●	●	●
Visit to Melk Abbey and walking tour in Melk or Winzer Krems – Vineyard and winery	70 53		●	●
Excursion packages with 15% discount*		371	598	804

*compared to the unit price (UP) on board. Package A incl. 7 excursions, Package B incl. 13 excursions and Package C incl. 16 excursions. Please refer to pages 132 – 147 for specific shore excursion details.

Transfers prices per person in EUR

Passau: train station – vessel or v.v.	28
Munich airport – vessel/Passau or v.v.	109

Parking place prices in EUR

Passau: 16 days outdoor parking	138
Passau: 16 days indoor garage	156

1,200 Miles on the Beautiful Blue Danube

15%
Early Booking
Discount

10 days | Vienna – Danube Delta – Bucharest or
11 days | Bucharest – Danube Delta – Vienna



Begin this remarkable journey with an overnight in the capital city of Bucharest with its vibrant old town, and European architecture and explore its stormy history. Travel out to the Romanian countryside to embark your cruise to the end of kilometer zero of the Danube River, where it empties into the Black Sea. Enjoy the natural beauty of the UNESCO protected Danube Delta – home to the largest reed bed in the world, protected by the fisherman’s village of St. George. Continue through seven countries (Romania, Bulgaria, Serbia, Croatia, Hungary and Austria) and five world famous capital cities (Vienna, Budapest, Bratislava, Belgrade and Bucharest). Be amazed as you pass through the “Iron Gates”, an imposing series of gorges where the Danube breaks through the border of Serbia and Romania surrounded by the Balkan and Carpathian Mountains. History, tradition and natural beauty make this an unforgettable trip.

Your itinerary

BUCHAREST – DANUBE DELTA – VIENNA

DAY/PORT	ARR	DEP	HIGHLIGHTS OF THE PROGRAM
1 Bucharest			Pick-up at the Bucharest airport Transfer to your 4–5 stars hotel in Bucharest Welcome Dinner and overnight in the hotel
2 Bucharest			Check-out after breakfast City tour of Bucharest with lunch Guided transfer to the Danube port Fetești Embarkation from 4 pm Welcome Cocktail and Welcome Dinner
Fetești		17:00	
3 Danube Delta			Cruise on the St. George branch to km 0 of the Danube and the Black Sea • Danube Delta nature experience
St. George	09:00	15:00	
4 Hârșova	07:00	08:00	• Constanța archeology and Black Sea coast
Fetești	12:00	12:30	Rejoin the ship
5 Svishtov	08:00	09:00	• Veliko Tarnovo and Arbanassi with lunch
Nikopol	13:00	16:00	Rejoin the ship
6 Iron Gates			Cruise day with passage of the Iron Gates
7 Belgrade	09:30	16:30	• Dynamic Belgrade & Kalemegdan Fortress • Topola, Oplenac and the Serbian Royal Dynasty
8 Mohács	11:30	14:00	• Traditions of the Hungarian Puszta
Kalocsa	19:00	20:00	Rejoin the ship
9 Budapest	08:00	21:00	• Budapest – Castle Hill & Historic Wonders • An Authentic Taste of Budapest Evening cruise Budapest with folklore show on board
10 Bratislava	15:30	19:00	• Bratislava – Beauty on the Danube Captain’s Gala Dinner
11 Vienna	09:00		Disembarkation after breakfast

All program services until embarkation in Fetești are included in the cruise price.
Excursions listed in blue are not included in the cruise price.
Please refer to pages 132 – 147 for specific shore excursion details.
We reserve the right to make amendments to the timetable and program.
For the Vienna – Danube Delta – Bucharest itinerary, see pages 80–81.

Price per person in double cabin from **2.279,-€**



DANUBE · DANUBE DELTA

DANUBE · DANUBE DELTA

The “Iron Gate”, is one of the most impressive valley breakthroughs in Europe.



Bucharest: View over the monumental Palace of Parliament

Your day program Cruise Bucharest–Danube Delta–Vienna

DAY 1 | ROMANIA: BUCHAREST

After landing at the Otopeni Airport in Bucharest, you will be picked-up at the airport for a transfer to the Hotel. Meet your fellow travelers at a Meet & Greet Dinner this evening.

DAY 2 | BUCHAREST · FETEȘTI

After breakfast, check out of your hotel and begin a full-day exploration of the capital city of Romania, dubbed “Little Paris” for its French-inspired architecture and avenues. Your adventure begins with a panoramic city tour along city’s broad boulevards, past the State University, the Triumphal Arch, Romanian Athenaeum and former Royal Palace. Continue on foot through the historic center and visit one of the oldest Orthodox churches in the city: Stavropoleos. After lunch in a local restaurant, take a picture of the Parliament Palace, constructed under famous Communist leader Nicolae Ceaușescu. Your afternoon concludes with a transfer to the Danube port of Fetești, for embarkation. After settling into your cabin, enjoy a Welcome Cocktail and a specially-prepared Dinner.

DAY 3 | DANUBE DELTA · ST. GEORGE

The natural beauty of the Danube Delta is on full display today. Spend the morning cruising one of the three main canals that make up the Danube Delta. The vessel reaches the point where the Danube, after winding its way through ten European countries, drains into the Black Sea. Thereafter, the vessel docks in the fisherman’s village of St. George. With the

village not being reachable by car, locals and visitors alike mostly navigate by bike, boat, or foot. For those wishing to delve further into the wetlands and reed beds home to otters, great cormorants and egrets, the optional Delta Safari boat excursion awaits.

DAY 4 | HÂRȘOVA · FETEȘTI

During breakfast, arrive in the small Romanian town of Hârșova. This is your gateway to an excursion to Constanța, the oldest continually inhabited city in Romania and its largest sea port, tracing its history some 2,500 years. The guided tour through this important cultural

Artful horse riding demonstration in the Puszta



and economic center highlights a synthesis of Greek, Roman, Balkan-oriental and European influences and offers views of the Great Mahmudiye Mosque, famous Genoese Lighthouse and Archaeology Museum. Step on the golden beaches of the Black Sea before returning to the ship. This evening, enjoy dinner as the vessel continues to Bulgaria.

DAY 5 | BULGARIA: SVISHTOV · NIKOPOL

This morning, the ship reaches the southernmost harbor on the Danube – Svishtov – which is situated on the Bulgarian side of the river. For those wanting to explore a little farther inland, an excursion including lunch is offered to the enchanting Veliko Tarnovo, the oldest town in Bulgaria. High on a peak

are the remains of the medieval town of Tsarevets, where 22 tsars made history in the 2nd Bulgarian empire. The flagships of the neighboring museum village of Arbanassi consist of the Church of the Nativity, adorned with splendid murals, and the rose oil, which is a speciality of this picturesque town. After a delicious lunch in a local restaurant, return to the ship which is now docked in Nikopol.

DAY 6 | IRON GATES

Today it is time to unwind and relax on board, as the vessel makes its way through the river’s narrowest points, known as the ‘Iron Gates’. Between Drobeta Turnu Severin and Moldova Veche, the Danube forces its way through the eye of a needle of huge gorges. In between, Europe’s highest rock sculpture, which shows the likeness of the Dacian king Decebalus. Power and beauty combined in 110 kilometers of river.

DAY 7 | SERBIA: BELGRADE

Today we will introduce your curiosity to Serbia’s capital. On our city tour of Belgrade, the Kalemegdan Fortress tells of eventful times. Timelessly beautiful: the view over the Danube and Sava. Afterwards, discover Terazije Square, the castle of Princess Ljubica, and the city’s indomitable dynamism. Would you rather ennoble the day? Then join us alternatively to Topola and Oplenac and trace the heritage of Serbian kings.

DAY 8 | HUNGARY: MOHÁCS · KALOCSA

The Puszta presents you a wonder of vastness on our excursion. Heaven and earth seem to merge. On the way you will visit the „paprika capital” Kalocsa. First you will nibble a few delicacies made of paprika, the „red gold” of the country, then you will experience Hungarian saddle strength at a rousing horse show.

DAY 9 | BUDAPEST

Good morning, you have a rendezvous with the „Queen of the Danube”. On the round trip she shows her seductive sides – with the State Opera House, Parliament, Heroes’ Square and Castle Hill with the Fishermen’s Bastion. The culinary refinements of this enchanting city will delight you on our afternoon excursion. In the evening, our light tour through Budapest will make your heart glow. It will catch fire during a spirited folklore show on board.

DAY 10 | SLOVAKIA: BRATISLAVA

The best way to take in the beauty of the Slovak capital is on our city tour. First up the castle hill and lose yourself in the distance. Then walk through the historic center of Bratislava and fall in love with baroque palaces and squares. A lot of attention to culinary detail will be served in the evening with our festive Captain’s Gala Dinner.

DAY 11 | AUSTRIA: VIENNA

After breakfast, we bid you farewell!

Cruise fares per person in EUR based on double occupancy of a cabin

TOUR DATE	VESSEL	CABIN TYPE & DECKS					
		C-4 Haydn	C-1 Haydn	B-4 Strauss	B-1 Strauss	A-1 Mozart	Suite Mozart
10 days Vienna – Bucharest							
28.07. – 06.08.	AMADEUS Nova	2.279	2.649	3.079	3.349	3.689	4.359
09.10. – 18.10.	AMADEUS Cara	2.399	2.789	3.249	3.529	3.879	4.589
11 days Bucharest–Vienna							
04.08. – 14.08.	AMADEUS Nova	2.529	2.939	3.429	3.729	4.099	4.839
16.10. – 26.10.	AMADEUS Cara	2.529	2.939	3.429	3.729	4.099	4.839

Early booking discount of 15% on the above-mentioned prices when booked by Nov 30, 2023.

Single cabin supplement per person for all dates:

C-4 + C-1: 15%, B-4: 30%, B-1: 50%, A-1: 60%, Suite: 100% of cruise price.

For cruise price inclusions, see page 16, for deck plans see page 118–131.

Excursion packages prices per person in EUR and if booked in advance

Cruise Vienna – Bucharest	UP	A	B	C
Bratislava – Beauty on the Danube	45	●	●	●
Schloss Hof – Baroque Palace and Estate	67			●
Esztergom, Visegrád castle and Szentendre	58		●	●
Budapest – Castle Hill & Historic Wonders	45	●		●
or An Authentic Taste of Budapest	48		●	
Vukovar, Osijek und Kopacki Rit	71		●	●
Dynamic Belgrade & Kalemegdan Fortress	46	●	●	●
Topola, Oplenac and the Serbian Royal Dynasty	46			●
Skadarlija, the artists’ quarter	64			●
Veliko Tarnovo – Cultural Capital of the Balkans	68			●
or Rouse with Basarbovo Monastery	66		●	
Danube Delta nature experience	64	●	●	●
Excursion packages with 15% discount*		170	338	488

Cruise Bucharest–Vienna	UP	A	B	C
Danube Delta nature experience	64	●	●	●
Constanța archeology and Black Sea coast	67		●	●
Veliko Tarnovo and Arbanassi with lunch	97			●
Dynamic Belgrade & Kalemegdan Fortress	46	●		●
or Topola, Oplenac and the Serbian Royal Dynasty	46		●	
Traditions of the Hungarian Puszta (from Mohács/to Kalocsa)	81		●	●
Budapest – Castle Hill & Historic Wonders	45	●	●	●
An Authentic Taste of Budapest	48			●
Bratislava – Beauty on the Danube	45	●	●	●
Excursion packages with 15% discount*		170	296	419

*compared to the unit price (UP) on board.

- Cruise Vienna–Bucharest: Package A incl. 4, Package B incl. 7 and Package C incl. 10 excursions,
- Cruise Bucharest–Vienna: Package A incl. 4, Package B incl. 6 and Package C incl. 8 excursions

Please refer to pages 132–147 for specific shore excursion details.

Transfers prices per person in EUR

Vienna: train station – vessel	34
Vienna: airport – vessel	40

Your itinerary

VIENNA – DANUBE DELTA – BUCHAREST

DAY/PORT	ARR	DEP	HIGHLIGHTS OF THE PROGRAM
1 Vienna			Embarkation from 4 pm Welcome Cocktail and Welcome Dinner
2 Vienna Bratislava	07:00	02:00 23:00	<ul style="list-style-type: none"> • Bratislava – Beauty on the Danube • Schloss Hof – Baroque Palace and Estate
3 Esztergom Budapest	07:00 12:00	08:30 21:00	<ul style="list-style-type: none"> • Esztergom, Visegrád castle and Szentendre • Budapest – Castle Hill & Historic Wonders or An Authentic Taste of Budapest Evening cruise Budapest with folklore show on board
4 Vukovar	14:30	22:00	• Vukovar, Osijek and Kopacki Rit
5 Belgrade	08:00	23:00	<ul style="list-style-type: none"> • Dynamic Belgrade & Kalemegdan Fortress • Topola, Oplenac and the Serbian Royal Dynasty • Skadarlija, the artists' quarter
6 Iron Gates			Cruise day with passage of the Iron Gates
7 Svishtov Rousse	07:00 11:30	08:00 13:30	<ul style="list-style-type: none"> • Veliko Tarnovo – Cultural Capital of the Balkans or Rousse with Basarbovo Monastery Rejoin the ship
8 Danube Delta St. George	12:00	15:00	Cruise on the St. George branch to km 0 of the Danube and the Black Sea <ul style="list-style-type: none"> • Danube Delta nature experience Captain's Gala Dinner
9 Fetești Bucharest	09:00 11:00		Disembarkation after breakfast Transfer to Bucharest and city tour with lunch Check into your 4–5 stars hotel in Bucharest Farewell dinner and overnight in the hotel
10 Bucharest	09:00		Check-out after breakfast Transfer to the Bucharest airport

All program services after disembarkation in Fetești are included in the cruise price.

Excursions listed in blue are not included in the cruise price.

Please refer to pages 132 – 147 for specific shore excursion details.

We reserve the right to make amendments to the timetable and program.

For cruise fares and excursion packages, see page 79.

Belgrade's fortress Kalemegdan is situated above the mouth of the Sava River into the Danube and offers a wide panoramic



Your day program

DAY 1 | AUSTRIA: VIENNA

This exciting journey along the Danube begins in Vienna, where you will embark in the afternoon. This evening, enjoy a Welcome Cocktail, followed by a Welcome Dinner.

DAY 2 | VIENNA · SLOVAKIA: BRATISLAVA

You arrive in the Slovakian capital of Bratislava before breakfast. This romantic city with its impressive Gothic and Baroque buildings is best explored in the morning, during the course of a city sightseeing tour, which takes you to all the most beautiful sights. Return to the vessel for lunch on board. As the afternoon unfolds, step into a bygone era of opulence and grandeur with a visit to the Imperial Schloss Hof, once owned by Empress Maria Theresia.

DAY 3 | HUNGARY: ESZTERGOM · BUDAPEST

Start your morning with a guided tour featuring the awe-inspiring basilica of Esztergom and the artistic soul of Szentendre. Meanwhile, the vessel continued gliding towards the Hungarian capital, where guests who opted for the tour will rejoin for lunch. This afternoon, discover the grandeur of Matthias Church and the fairy-tale-like Fisherman's Bastion on a tour of Budapest. Alternatively, embark on "An Authentic Taste of Budapest", starting at the market hall and continuing at the famous geothermal baths. As a special treat this evening, local artists come on board to entertain with dances and music, while the vessel cruises the Danube through this iconic city by night.

DAY 4 | CROATIA: VUKOVAR

Your cruise ship reaches Vukovar after lunch, and you can take a city sightseeing tour,



Starting from the fishing village of St. George, you can discover the flora and fauna of the Danube Delta Biosphere Reserve by excursion boat

followed by an excursion to the Kopacki Rit nature park. This 18-hectare nature reserve, situated at the confluence of the Drava and Danube Rivers, is home to a diverse bird population and provides a protected environment for many species of plants and animals. Explore this wetland by boat and enjoy the unspoiled beauty of nature before returning to your vessel for dinner. Your ship departs during the night.

DAY 5 | SERBIA: BELGRADE

Enjoy a new day in a new country! You reach Belgrade, the vibrant and distinctly western-influenced capital of Serbia at breakfast time. This metropolis is home to many attractions from various eras and cultures, and you can view these during the course of a morning sightseeing tour. After lunch, you can join an excursion to Topola and Oplenac, where you can see the famous St. George's Church, which is the final resting place of most of the Serbian royal family.

Hand in hand on the fishermen bastion of Budapest



After dinner, take pleasure in an outing to the lively artists' quarter Skardalija. The ship will leave the harbor before midnight.

DAY 6 | IRON GATES

Your journey takes you through the "Iron Gates", one of the most imposing gorges in Europe. One of the most beautiful stretches along the route includes the "Cazan" near the town of Orșova, where the riverbed recedes to 200 meters width and 80 meters depth and passengers will be rewarded with a fascinating view of the surrounding Carpathian Mountains and the Balkan mountain range. The small abbey church Mraconia, which is situated on the Romanian side of the Danube at the water's edge, is equally worth seeing.

DAY 7 | BULGARIA: SVISHTOV · ROUSSE

This morning, join us on a tour to discover the timeless charm of the "City of Tsars", Veliko Tarnovo. Perched high on the hills of northern Bulgaria, this former capital of the

"I loved discovering so many countries in such a relaxed and comfortable way."

Theodor S.

Second Bulgarian Empire exudes a captivating blend of history, culture, and scenic beauty. Alternatively, explore the rock monastery of Basarbovo followed by an insightful city tour of Rousse. With its strategic location on the Danube, Rousse has been a significant crossroads of trade and cultural exchange for centuries.

DAY 8 | ROMANIA: DANUBE DELTA · ST. GEORGE

Your journey continues through the Danube Delta, one of the largest wetlands in the world. You travel along St. George's Canal, also known figuratively as the "end of the Danube" – the so-called "kilometre zero" – where the mighty river flows into the Black Sea. Your destination is the nearby fishing village of St. George, which is the starting point for an exciting Delta boat safari – a great way to discover and get close to the impressive natural landscape and its fascinating flora and fauna. In the evening you can enjoy a festive Gala Dinner with your captain.

DAY 9 | FETEȘTI · BUCHAREST

During breakfast you reach Fetești, where you leave your AMADEUS vessel – but your trip is not over yet! You will be transferred to Bucharest, and check in at a centrally-located 4- or 5-star hotel. Thereafter, you can take part in a city sightseeing tour through this vibrant metropolis. At lunch time, you will dine in Bucharest, while in the evening you can enjoy a local specialties at a farewell dinner.

DAY 10 | BUCHAREST

You can enjoy breakfast in your hotel before check-out and your transfer to the Otopeni airport, where your homeward journey begins. We hope to welcome you again soon!

France: Seine and Rhône · Saône

Paris, Normandy and
the River Seine 84 – 87

8 days Paris – Le Havre – Paris

Treasures of Burgundy
and Provence 88 – 91

8 days Lyon – Chalon-sur-Saône – Arles – Lyon



© FenlioQ/Shutterstock.com

Avignon: evening view over the Rhône to the Pont Saint-Bénézet and the Papal Palace

15%
Early Booking
Discount

Paris, Normandy and the River Seine

8 days | Paris – Le Havre – Paris

This week-long cruise aboard the AMADEUS Diamond, begins and ends in Paris – the city of light. Combine the most romantic city in the world with a fascinating journey into the past of the Impressionist masters. Follow the footsteps of Van Gogh, Cezanne and Gauguin while winding along the Seine River into the beautiful Normandy region to Le Havre on the rugged Atlantic Coast. Normandy was the stage of one of the most pivotal military operations in history: D-Day during World War II. Idyllic Normandy villages, the “museum town” of Rouen and the picturesque harbor town of Honfleur are among the wonders to be explored during this cruise.

Your itinerary

DAY/PORT	ARR	DEP	HIGHLIGHTS OF THE PROGRAM
1 Paris			Embarkation from 4 pm Welcome Cocktail and Welcome Dinner
2 Conflans-Ste.-Honorine	01:30	17:00	• Painters' village Auvers-sur-Oise
3 Rouen	08:00	17:30	• Rouen walking tour • Pressoir d'Or and free time in Lyons-la-Forêt
4 Le Havre	03:30		• Honfleur – city of art and history • Étretat – cliffs and walking tour Chanson singers on board
5 Le Havre Caudebec-en-Caux	09:00 15:00	22:00	• Full-day “Fascinating Normandy” with lunch Rejoin the ship or Fécamp with Palais Bénédicte
6 Les Andelys Vernon	08:00 11:30	09:00 13:30	• Monet's Muses & Château Gaillard Rejoin the ship • Joséphine, Napoleon and Château de Malmaison Rejoin the ship
Mantes-la-Jolie	17:30	18:30	Rejoin the ship
7 Paris	03:30		• Paris – Cafés, Cathedrals & City of Light • Montmartre walking tour Captain's Gala Dinner
8 Paris			Disembarkation after breakfast

Excursions listed in blue are not included in the cruise price.
Please refer to pages 132 – 147 for specific shore excursion details.
We reserve the right to make amendments to the timetable and program.

Price per person in double cabin from **1.359,-**€

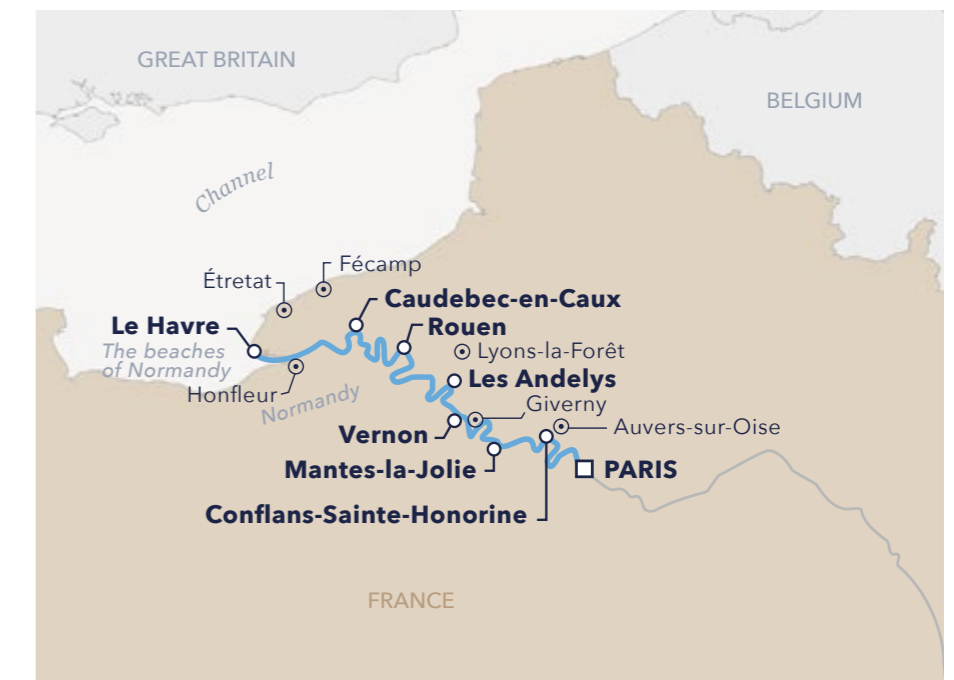

Paris: Partial view of the „Place du Tertre” in the Montmartre district with a view of the Sacré-Cœur Basilica



Honfleur is nestled along the scenic estuary of the Seine River

Your day program Cruise Paris – Le Havre – Paris

DAY 1 | FRANCE: PARIS

Embark this afternoon in Paris, the romantic City of Light. After unpacking, join your fellow travelers for a Welcome Cocktail, followed by a specially-prepared Welcome Dinner.

DAY 2 | CONFLANS-SAINTE-HONORINE

Your ship reaches Conflans-St.-Honorine early in the morning, where the rivers Oise and Seine meet at their confluence. Join a guided tour to the little town of Auvers-sur-Oise, an inspiration to many Impressionist masters, including Cezanne, Pissarro and Daubigny. The most famous of these artists is Vincent van Gogh. Depart late this afternoon.

DAY 3 | ROUEN

This morning, join a walking tour of the capital of the Normandy region and visit the cathedral that inspired Claude Monet, and the modern Church of Joan of Arc with its magnificent 16th century stained-glass windows. This afternoon, go back to the 17th century by visiting Le Pressoir d'Or, a typical farmhouse where you can taste cidre and view the orchard cellar and the museum dedicated to the old apple press. Afterwards, there is enough time left to visit Lyons-la-Forêt, known as one of the most beautiful villages

of France, situated 30 km east of Rouen, in a forested setting in Normandy. Late this afternoon, the AMADEUS vessel departs as it continues northward.

DAY 4 | LE HAVRE

The harbor of Le Havre is your convenient base for two optional land explorations. This morning, opt for a tour to the nearby city of Honfleur, with its picturesque old harbor lined with 16th – 18th century townhouses.

Admire the bizarre chalk cliff coast of Étretat



After lunch, explore the Norman coastline on a walk along Étretat's cliff-top paths for a view of the steep chalk rocks with impressive needle-like formations. On board your AMADEUS vessel this evening, enjoy the music of local chanson singers.

DAY 5 | LE HAVRE · CAUDEBEC-EN-CAUX

Today, join us on a full-day Norman journey. Experience a combination of rich culinary traditions and historic landmarks including the closest harbor linked with the liberation of Western Europe after D-Day – the city of Arromanches with its remnants of World

War II Mulberries. Or choose an excursion to Fécamp, a seaside resort and home to Le Palais Bénédicte, which produces the famous liqueur. The vessel departs after dinner this evening.

DAY 6 | LES ANDELYS · VERNON · MANTES-LA-JOLIE

Today, there are several choices for the day's adventures. Relax in little town of Les Andelys or venture farther afield to the remains of the English king's stronghold: Château Gaillard. Continue to Giverny, to visit the home of Impressionist Claude Monet and the beautiful gardens which were inspiration for several works of art. Indulge in a delightful lunch on board before embarking on an excursion to Château de Malmaison, the former residence of Joséphine and Napoleon Bonaparte, to immerse yourself in the privacy of the Imperial couple. After you rejoin the ship in Mantes-la-Jolie later this afternoon, your ship continues to Paris. This evening enjoy the music of local chanson singers.

DAY 7 | PARIS

In the early morning, it is once more "Bien-venue" to the French capital. Explore the sights of the Eiffel Tower and the bustling Champs-Élysées, one of the world's most famous commercial streets, during a morning city tour. Later in the day, join us as we delve into the allure of Montmartre, an eternal muse for creativity and expression, located on the highest hill in northern Paris. From its cobbled streets and quaint cafes to its iconic Sacré-Coeur, Montmartre offers a unique experience that transports visitors back to the "La Belle Époque" era. Late this afternoon, enjoy a festive Captain's Gala Dinner and admire the city lights of the French capital.

DAY 8 | PARIS

After breakfast, your AMADEUS crew bids you "adieu" and wishes you a safe journey home. We hope to see you again soon!

Rouen: Visit to the market



Cruise fares per person in EUR based on double occupancy of a cabin

TOUR DATE	VESSEL	CABIN TYPE & DECKS					
		C-4 Haydn	C-1 Haydn	B-4 Strauss	B-1 Strauss	A-1 Mozart	Suite Mozart
8 days Paris – Le Havre – Paris							
03.04. – 10.04.	AMADEUS Diamond	1.359	1.629	2.039	2.259	2.599	3.049
10.04. – 17.04.	AMADEUS Diamond	1.389	1.669	2.089	2.319	2.669	3.129
24.04. – 01.05.	AMADEUS Diamond	1.659	1.989	2.479	2.759	3.169	3.719
29.05. – 05.06.	AMADEUS Diamond	2.189	2.549	2.969	3.229	3.869	4.189
12.06. – 19.06.	AMADEUS Diamond	2.189	2.549	2.969	3.229	3.869	4.189
26.06. – 03.07.	AMADEUS Diamond	2.189	2.549	2.969	3.229	3.869	4.189
17.07. – 24.07.	AMADEUS Diamond	2.079	2.419	2.819	3.059	3.679	3.979
14.08. – 21.08.	AMADEUS Diamond	2.189	2.549	2.969	3.229	3.869	4.189
04.09. – 11.09.	AMADEUS Diamond	2.189	2.549	2.969	3.229	3.869	4.189
18.09. – 25.09.	AMADEUS Diamond	2.189	2.549	2.969	3.229	3.869	4.189
02.10. – 09.10.	AMADEUS Diamond	2.189	2.549	2.969	3.229	3.869	4.189

Early booking discount of 15% on the above-mentioned prices when booked by Nov 30, 2023. This cruise departure is also bookable as golf cruise, page 98.

Single cabin supplement per person for all dates:

C-4+C-1: 15%, B-4: 30%, B-1: 50%, A-1: 60%, Suite: 100% of cruise price.

True single cabins with no single supplement available on AMADEUS Diamond at the price of C-4 cabins.

For cruise price inclusions, see page 16, for deck plans see page 118–131.

Excursion packages prices per person in EUR and if booked in advance

Cruise Paris – Le Havre – Paris	UP	A	B	C
Painters' village Auvers-sur-Oise	120	●	●	●
Rouen walking tour	24	●	●	●
Pressoir d'Or and free time in Lyons-la-Forêt	79			●
Honfleur – city of art and history	63		●	●
Étretat – cliffs and walking tour	63	●	●	●
Full-day "Fascinating Normandy" with lunch or Fécamp with Palais Bénédicte	205 80		●	●
Monet's Muses & Château Gaillard	97	●	●	●
Joséphine, Napoleon and Château de Malmaison	88			●
Paris – Cafés, Cathedrals & City of Light	63	●	●	●
Montmartre walking tour	67			●
Excursion packages with 15% discount*		312	434	739

*compared to the unit price (UP) on board.

Package A incl. 5 excursions, Package B incl. 7 excursions and Package C incl. 10 excursions. Please refer to pages 132 – 147 for specific shore excursion details.

Transfers prices per person in EUR

Paris: airport (CDG) – vessel or v.v.	67
Paris: airport (CDG) – hotel or v.v.	67

Treasures of Burgundy and Provence

8 days | Lyon – Chalon-sur-Saône – Arles – Lyon

15%
Early Booking
Discount

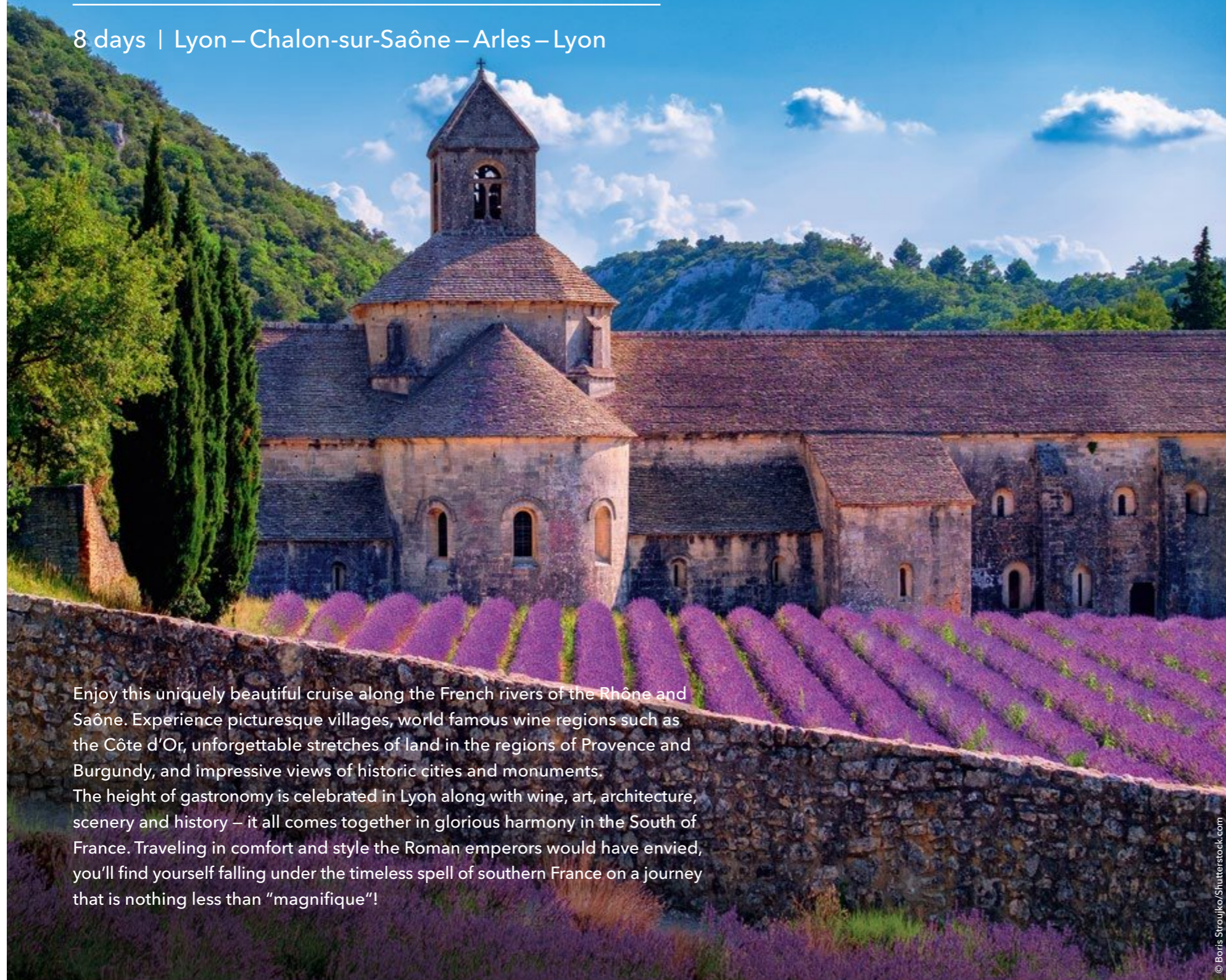

Enjoy this uniquely beautiful cruise along the French rivers of the Rhône and Saône. Experience picturesque villages, world famous wine regions such as the Côte d'Or, unforgettable stretches of land in the regions of Provence and Burgundy, and impressive views of historic cities and monuments. The height of gastronomy is celebrated in Lyon along with wine, art, architecture, scenery and history – it all comes together in glorious harmony in the South of France. Traveling in comfort and style the Roman emperors would have envied, you'll find yourself falling under the timeless spell of southern France on a journey that is nothing less than "magnifique"!

Blooming purple lavender fields at Senanque monastery in the colorful Provence

Your itinerary

DAY/PORT	ARR	DEP	HIGHLIGHTS OF THE PROGRAM
1 Lyon		22:00	Embarkation from 4 pm Welcome Cocktail and Welcome Dinner
2 Mâcon	06:00	18:00	<ul style="list-style-type: none"> • Mâcon and the Beaujolais • Château de Pierreclos with wine tasting or Visit to Cluny Abbey
3 Chalon-sur-Saône	01:00	14:30	<ul style="list-style-type: none"> • Beaune and the Burgundy • Medieval Brancion and Cormatin
Tournus	17:30	19:30	Rejoin the ship
4 Lyon	07:00	12:00	<ul style="list-style-type: none"> • Lyon – Gastronomic capital of France or Les Halles by Paul Bocuse with tasting
5 Avignon	09:00	19:00	<ul style="list-style-type: none"> • Avignon walking tour with Pope Palace • Roman aqueduct Pont du Gard and Uzès Live performance by local musicians on board
6 Arles	00:01	18:30	<ul style="list-style-type: none"> • Arles walking tour with Arena • Camargue Nature Reserve
7 Châteauneuf-du-Rhône	04:30	08:30	<ul style="list-style-type: none"> • Valley of the Ardèche Gorge or Grignan with truffle farm and tasting
Le Pouzin	12:30	14:00	Rejoin the ship Captain's Gala Dinner
8 Lyon	02:00		Disembarkation after breakfast

Excursions listed in blue are not included in the cruise price. Please refer to pages 132 – 147 for specific shore excursion details. We reserve the right to make amendments to the timetable and program.

Price per person in double cabin from **1.179,-**€





The Mâconnais district is located in the south of the Burgundy wine region in France, west of the Saône river.

Your day program Cruise Lyon – Chalon-s.-S. – Arles – Lyon

DAY 1 | FRANCE: LYON

This afternoon, embark your vessel settle into your cabin. This evening, enjoy a Welcome Cocktail, followed by a specially prepared Welcome Dinner.

DAY 2 | MÂCON

In the morning, your ship arrives in Mâcon, located in southern Burgundy. With a history stretching back more than 2,000 years, Mâcon is an architectural treasure trove and a gateway to the vineyards of the Côte Mâconnais. This historic wine region produces some of the finest and most expensive wines in the world. Enjoy a guided tour and admire the peaceful vineyards of the Beaujolais and Mâconnais wine regions. A highlight is the visit to the "Hameau Duboeuf" wine museum, featuring the history and production of Burgundy wines, and a wine tasting. After lunch on board, join the afternoon excursion to Cluny Abbey, which was founded in 910 and was home to over 10,000 monks at its height, or visit Château de Pierreclos with its romantic wine cellars and vineyard. Enjoy dinner on board in the evening.

DAY 3 | CHALON-SUR-SAÔNE · TOURNUS

Continue exploring the Burgundy wine region in Chalon-sur-Saône, where half-timbered houses overlook a square teeming with art galleries and specialty shops. Enjoy a scenic drive through the Burgundy wine route on the morning tour. Your bus will stop in Beaune, where you will see the beautiful Hôtel-Dieu and enjoy a wine tasting at one of Beaune's famous cellars. After lunch on board, unwind and admire the scenery as the vessel conti-

nues along the Saône or, alternatively, join the afternoon excursion, which departs from Chalon-sur-Saône overland for the medieval towns of Brancion and Cormatin. The Château de Cormatin is a beautiful castle with magnificent French gardens. It was built in the 17th Century with the aim to impress. Rejoin your vessel in time for dinner on board.

DAY 4 | LYON

Today your AMADEUS vessel returns to Lyon, which is known not only for its architectural beauty but also for its gastronomic excellence. On the guided tour, discover this UNESCO World Heritage site with its most famous landmarks including the Basilica of Notre-Dame

"I've tasted some of the best food and wine – such a great way to see this part of France."

Sean F.

de Fourvière and the charming Renaissance Vieux Lyon (Old Lyon), or join the excursion to the covered food market of Paul Bocuse and sample the local delicacies. At midday, the ship leaves Lyon.

DAY 5 | AVIGNON

Spend the day exploring the Provençal city of Avignon and discovering its momentous history. In the morning, take part in a guided walking tour of Avignon, the seat of the Catholic popes from 1309 to 1377. Admire the grand Palace of the Popes, one of the

Relaxation on the Pool Deck with swimming pool and Lido-Bar



world's most fascinating examples of Gothic architecture and the Pont d'Avignon. After lunch, join the excursion to the hilltop town of Uzès and to the Pont du Gard, a Roman aqueduct and great masterpiece of engineering. In the evening, dinner is followed by entertainment by a local music band. We depart for Arles this evening.

DAY 6 | AVIGNON · ARLES

Old Arles is a delight to wander in and explore, no wonder it once captured the imagination of the brilliant Impressionist painter, Vincent van Gogh. Learn more about its rich history during the morning tour. Inside the Roman amphitheater, get a good impression of what being a spectator of gladiator fights was like at the end of the first century. This afternoon, recharge in the tranquility of unspoilt scenery by joining the excursion to the natural beauty of the Camargue's salt marshes, home to the renowned Camargue bulls and wild white horses. This nature preserve is also one of the few European habitats which supports the greater flamingo. After a full day in Arles, your vessel will continue cruising the Rhône River.

DAY 7 | CHÂTEAUNEUF-DU-RHÔNE · LE POUZIN

You can choose to spend a day on board or join a morning guided tour the Ardèche Gorge, another natural wonder of this area. Visit the "Grand Canyon of Europe," where spectacular limestone cliffs tower over the meandering river below. France is a leading producer of black truffles, so the alternative is an exploration of the world of truffles with a visit and tasting to a local truffle farm. Rejoin the vessel in Le Pouzin in time for lunch. This afternoon, relax on board as your ship makes its way back up the waterways of the Provence. This evening, celebrate your cruise experience at the Captain's Gala Dinner.

DAY 8 | LYON

After breakfast, we bid you farewell!

Camargue Nature Reserve



Cruise fares per person in EUR based on double occupancy of a cabin

TOUR DATE	VESSEL	CABIN TYPE & DECKS					
		C-4 Haydn	C-1 Haydn	B-4 Strauss	B-1 Strauss	A-1 Mozart	Suite Mozart
8 days	Lyon – Chalon-sur-Saône – Arles – Lyon						
28.03. – 04.04.	AMADEUS Provence	1.179	1.409	1.759	1.959	2.309	2.689
04.04. – 11.04.	AMADEUS Provence	1.529	1.829	2.289	2.549	2.999	3.489
11.04. – 18.04.	AMADEUS Provence	1.699	2.039	2.549	2.829	3.339	3.879
18.04. – 25.04.	AMADEUS Provence	1.919	2.309	2.799	3.039	3.619	4.049
25.04. – 02.05.	AMADEUS Provence	2.299	2.669	3.109	3.379	4.059	4.389
02.05. – 09.05.	AMADEUS Provence	2.299	2.669	3.109	3.379	4.059	4.389
09.05. – 16.05.	AMADEUS Provence	2.419	2.809	3.269	3.559	4.269	4.619
23.05. – 30.05.	AMADEUS Provence	2.419	2.809	3.269	3.559	4.269	4.619
13.06. – 20.06.	AMADEUS Provence	2.419	2.809	3.269	3.559	4.269	4.619
20.06. – 27.06.	AMADEUS Provence	2.419	2.809	3.269	3.559	4.269	4.619
27.06. – 04.07.	AMADEUS Provence	2.419	2.809	3.269	3.559	4.269	4.619
08.08. – 15.08.	AMADEUS Provence	2.299	2.669	3.109	3.379	4.059	4.389
19.09. – 26.09.	AMADEUS Provence	2.419	2.809	3.269	3.559	4.269	4.619
26.09. – 03.10.	AMADEUS Provence	2.419	2.809	3.269	3.559	4.269	4.619
10.10. – 17.10.	AMADEUS Provence	1.949	2.349	2.849	3.099	3.679	4.119
17.10. – 24.10.	AMADEUS Provence	1.949	2.349	2.849	3.099	3.679	4.119
24.10. – 31.10.	AMADEUS Provence	1.809	2.189	2.649	2.879	3.429	3.829
31.10. – 07.11.	AMADEUS Provence	1.259	1.509	1.929	2.099	2.479	2.879

Early booking discount of 15% on the above-mentioned prices when booked by Nov 30, 2023.

Single cabin supplement per person for all dates:

C-4+C-1: 15%, B-4: 30%, B-1: 50%, A-1: 60%, Suite: 100% of cruise price.

For cruise price inclusions, see page 16, for deck plans see page 128.

Excursion packages prices per person in EUR and if booked in advance

Cruise Lyon – Chalon-sur-Saône – Arles – Lyon	UP	A	B	C
Mâcon and the Beaujolais	89	●	●	●
Château de Pierreclos with wine tasting or Visit to Cluny Abbey	70 76		●	●
Beaune and the Burgundy	87	●	●	●
Medieval Brancion and Cormatin	76			●
Lyon – Gastronomic capital of France or Les Halles by Paul Bocuse with tasting	50 60		●	●
Avignon walking tour with Pope Palace	50	●	●	●
Roman aqueduct Pont du Gard and Uzès	61			●
Arles walking tour with Arena	36	●	●	●
Camargue Nature Reserve	59		●	●
Valley of the Ardèche Gorge or Grignan with truffle farm and tasting	59 85	●	●	●
Excursion packages with 15% discount*		295	425	577

*compared to the unit price (UP) on board.

Package A incl. 5 excursions, Package B incl. 8 excursions and Package C incl. 10 excursions. Please refer to pages 132 – 147 for specific shore excursion details.

Transfers prices per person in EUR

Lyon: train station – vessel or v.v.	52
Lyon: airport – vessel or v.v.	77

Parking place prices in EUR

Lyon: 8 days parking	135
----------------------	-----

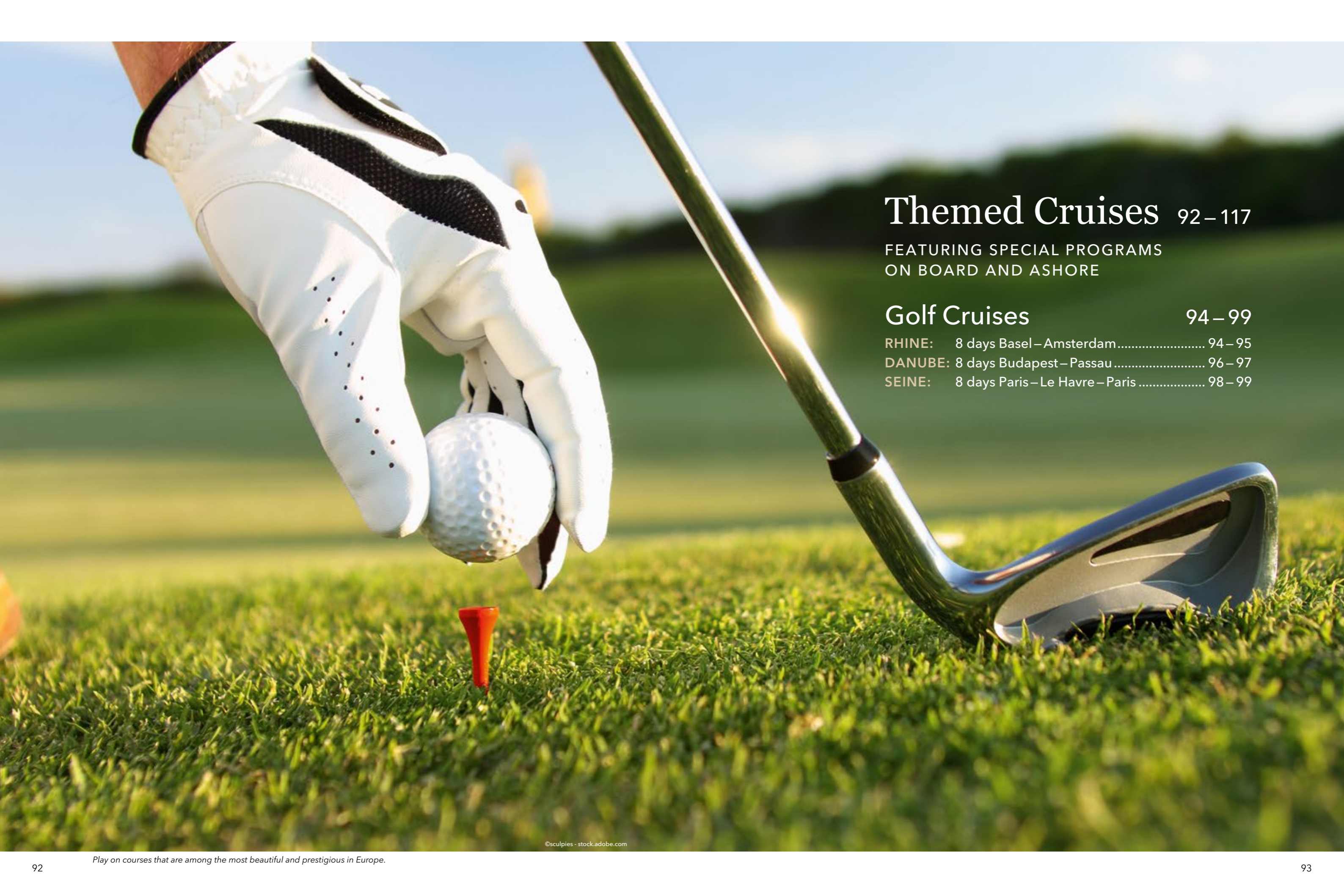

Themed Cruises 92–117

FEATURING SPECIAL PROGRAMS
ON BOARD AND ASHORE

Golf Cruises 94–99

- RHINE: 8 days Basel–Amsterdam..... 94–95
- DANUBE: 8 days Budapest–Passau 96–97
- SEINE: 8 days Paris–Le Havre–Paris 98–99

©sculpiers - stock.adobe.com

Golf Cruises on the Rhine

8 days | Basel – Amsterdam



Jakobsberg Golf Club: One of the most beautiful golf courses – between forests and vineyards and with a unique view of the Marksburg and the Rhine.

Your itinerary

DAY/PORT	ARR	DEP	HIGHLIGHTS OF THE PROGRAM
1 Basel		17:00	Embarkation from 4 pm Welcome Cocktail and Welcome Dinner Briefing on all golf clubs and starting times
2 Strasbourg	09:00	23:00	• Morning transfer and round of golf at Le Kempferhof Golf Club
3 Speyer	07:00	12:00	• Morning transfer and round of golf at St. Leon-Rot Golf Club
Mannheim	14:00	23:59	(Rejoin the ship in the afternoon)
4 Rüdesheim	07:00	12:00	• Morning transfer and round of golf at Jakobsberg Golf Club
Koblenz	15:30		• Koblenz walking tour with Ehrenbreitstein Fortress (optional)
5 Koblenz		06:00	Scenic cruising on the Moselle River • Cochem walking tour & Reichsburg Castle (included)
Cochem	13:30	18:00	
6 Cologne	07:00	13:00	• Morning transfer and round of golf at Golf & Country Club Gut Velderhof
Düsseldorf	16:00	16:30	Rejoin the ship · Captain's Gala Dinner
7 Amsterdam	08:00		• Amsterdam & Iconic canal cruise (included) • Haarlem – art, history and Dutch lifestyle* or A Dutch Trip to Waterland*
8 Amsterdam			Disembarkation after breakfast

Excursions are listed in blue. *Excursion operate at the same time, only one may be booked. Please refer to pages 132 – 147 for specific shore excursion details. Golf package for a minimum of 20 participants and a maximum of 40. We reserve the right to make amendments to the timetable and program.

Price per person in double cabin from **3.469,-** €

Travel on the romantic Rhine from Basel to Amsterdam, enjoying a stress-free golf vacation with exceptional service and great golf at some of Europe's most spectacular venues. Throughout the cruise, enjoy the services and in-depth knowledge of our golf expert. With exciting golfing opportunities, breathtaking scenery and true Austrian hospitality, this cruise is sure to be unforgettable!

The Golf Clubs

LE KEMPFERHOF GOLF CLUB

Some 20 minutes from Strasbourg, in the beautiful Alsace, Le Kempferhof Golf stretches across 85 hectares of tranquil, natural woodland. The 18-hole course was designed by the American architect Robert von Hagge and opened in 1990. Hundred-year-old oaks, poplars and beech trees line the beautiful and challenging course, which features 13 water hazards, undulating fairways, large bunkers and immaculate greens. The Château-Hôtel was inspired by Gaudi and built in 1865 by Jean de Darstein.

ST. LEON-ROT GOLF CLUB

Masterminded by the founder Dietmar Hopp, St. Leon-Rot opened in 1997 and became famous in 2002 when the world's number one player Tiger Woods won his third Deutsche Bank SAP Open there. One of the "Leading Golf Courses in Germany", the complex boasts two 18-hole championship courses and a 9-hole executive course. Architect Dave Thomas designed St. Leon as a links-style course, reminiscent of

Scottish or Irish golf courses. The Rot course retains much of the original river wetland, ensuring that the course offers not only charming scenery but also presents special challenges. The island green of the Rot course and the island fairway of the St. Leon course are the signature holes of the club.

JAKOBSBERG GOLF CLUB

Set high above the Lorelei valley in the Upper Middle Rhine Valley, deservedly a UNESCO World Heritage Region, the Jakobsberg Golf Resort boasts a truly majestic setting. The 18-hole golf course is nestled between forests and vineyards and was built by Wolfgang Jarsombek, who based his design on a model by architect Robert Trent Jones Jr. The course serves as a 3rd level tour venue. The strongly modelled fairways each feature four different teeing grounds, as well as large bunkers, water hazards and undulating greens. The course is sporting but fair and you may find that your greatest golfing challenge at the Jakobsberg Golf Resort will be not to get distracted by the views of the Lorelei valley and Marksburg castle.

GOLF & COUNTRY CLUB VELDERHOF

The Velderhof Golf Club extends over an idyllic and tranquil lowland surrounded by extensive forests. The championship course provides suitable challenges for players of all handicap levels. The 27 holes stretch over 3 courses, with 9-hole and 18-hole options. The golf course follows the ancient lines originally carved into the landscape by the Rhine River. It features fast greens, wide fairways, well-placed fairway bunkers and water hazards, all surrounded by picturesque streams and biotopes. The driving range features brand-new grass tees which extend over 2,500m² in front of the range.

Unique golf experience



Cruise fares

per person in EUR based on double occupancy of a cabin

TOUR DATE	VESSEL	CABIN TYPE & DECKS					
		C-4 Haydn	C-1 Haydn	B-4 Strauss	B-1 Strauss	A-1 Mozart	Suite Mozart
8 days Basel – Amsterdam							
12.10. – 19.10.	AMADEUS Star	3.469	3.799	4.199	4.439	4.779	5.339

Early booking discount of 15% on the above-mentioned prices when booked by Nov 30, 2023. This cruise departure is also offered as cruise-only option. Golf package (€ 1.400 per person) is optionally added to the regular cruise itinerary, page 26. Single cabin supplement per person for all dates: C-4+C-1: 15%, B-4: 30%, B-1: 50%, A-1: 60%, Suite: 100% of cruise price. For cruise price inclusions, see page 16, for deck plans see page 126.

Excursions

prices per person in EUR

Koblenz walking tour with Ehrenbreitstein Fortress (in the afternoon)	52
Cochem walking tour & Reichsburg Castle	incl.
Amsterdam & iconic canal cruise	incl.
Haarlem – art, history and Dutch lifestyle* or A Dutch Trip to Waterland*	46
	57

*Excursion operate at the same time, only one may be booked. Please refer to pages 132 – 147 for specific shore excursion details.

Transfers

prices per person in EUR

Basel: train station – vessel	65	Amsterdam: vessel – train station	50
Basel: airport – vessel	65	Amsterdam: vessel – airport	59

Golf Inclusions

- 4 rounds of golf at top golf courses
 - Green fees, reserved & pre-paid tee times, driving range balls
 - Shared electric golf carts (subject to availability)
 - Transfer from ship to golf club and return to ship
 - Lunch box (on request)
 - Ship crew assistance with golf bags from/to cabin (on request)
 - Services of an experienced golf expert and tour leader
 - Selected excursions as outlined in the itinerary (included)
- Participants:** min. 20, max. 40 persons



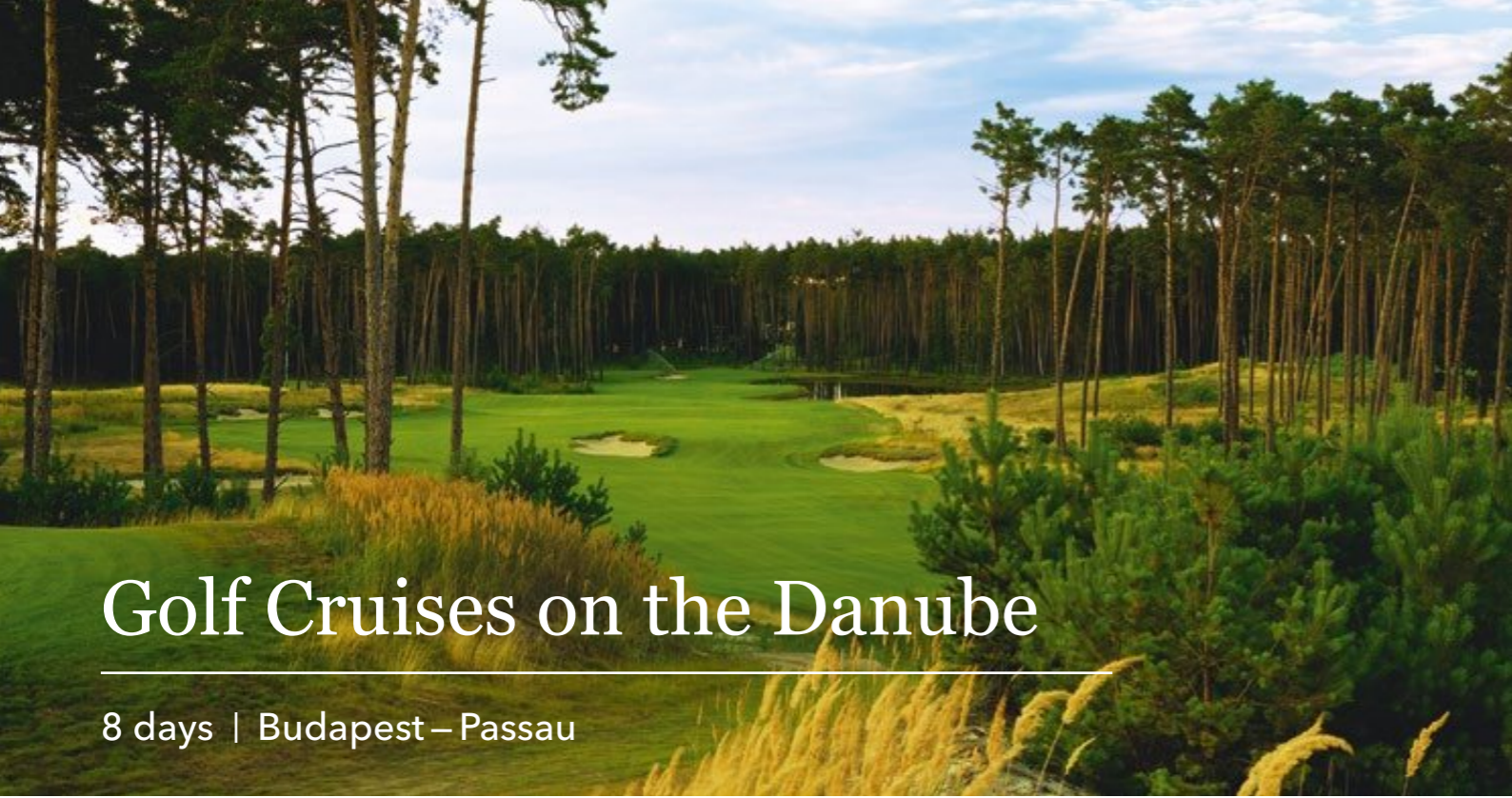

Golf Cruises on the Danube

8 days | Budapest – Passau

Penati Golf Club: Wide undulating fairways, a diversity of greens, challenging steep bunkers, beautiful and variable teeing placements...

Your itinerary

DAY/PORT	ARR	DEP	HIGHLIGHTS OF THE PROGRAM
1 Budapest			Embarkation from 4 pm · Welcome Cocktail and Welcome Dinner · Briefing on all shore excursions, golf clubs and starting times Evening cruise with folklore show on board
2 Budapest Esztergom	18:30	13:30 20:00	• Morning transfer and round of golf at Pannónia Golf & Country Club · (Rejoin the ship)
3 Bratislava	08:00	23:00	• Morning transfer and round of golf at Penati Golf Club
4 Vienna	07:00	23:59	• Morning transfer and round of golf at Fontana Golf Club • "Sound of Vienna" classical concert (Cat. B) in the evening (included)
5 Dürnstein	08:00	12:00	• Full-day trip and a round of golf at Lengenfeld Golf Club (optional)* or Dürnstein walking tour with wine tasting in the morning (included)
Emmersdorf	15:00	19:00	• Melk Abbey – A Baroque Jewel (optional)
6 Linz	07:00	08:30	• Morning transfer and round of golf at Beckenbauer Golf Club (Rejoin the ship) · Captain's Gala Dinner
Passau	17:00	18:30	
7 Regensburg	10:00	20:00	• Full-day trip and a round of golf at the Regensburg Golf Club (optional) or Regensburg walking tour (included)* • Danube Gorge, Weltenburg Abbey and beer tasting (optional)* or Thurn & Taxis Palace, brewery with tasting* Bavarian evening on board
8 Passau	08:00		Disembarkation after breakfast

Excursions are listed in blue. *Excursion operate at the same time, only one may be booked. Please refer to pages 132 – 147 for specific shore excursion details. Golf package for a minimum of 20 participants and a maximum of 40. We reserve the right to make amendments to the timetable and program.

Price per person in double cabin from **3.479,-** €

This itinerary along the elegant Danube from Budapest to Passau, offers golf at four different courses, which are nestled amid stunning scenery, with guaranteed tee times, transportation, green fees, shared golf carts, culture, sightseeing and fine dining included. Throughout the cruise, enjoy the services and guidance of our golf expert.

The Golf Clubs

PANNÓNIA GOLF & COUNTRY CLUB

East of Budapest, the Pannónia Golf and Country Club is a 18-hole championship course was designed by the prominent Austrian architect Hans G. Erhardt and opened in 1996. The clubhouse blends beautifully with the wine-growing scenery. Idyllic lakes serve as obstacles for eight holes. Doglegs provide suspense at holes 9 and 11 and pin placements may also present a challenge at the hilly greens.

PENATI GOLF RESORT

The club offers two 18-hole courses – the challenging Legend course, which opened in 2012 and stretches over 95 hectares, and the Heritage course, which opened in 2013. The signature holes of the Legend course are the 716-meter 15th hole, which is the longest hole in Europe, as well as the final hole, which is the narrowest hole on the green and plays onto a beautiful island green, and will undoubtedly provide an exciting finish to the game. The second 18-hole course, the Heritage course, was designed by Jonathan Davison and the world-renowned Mick McShane and returns to the roots of island-design courses.

FONTANA GOLF CLUB

Situated about 30 kilometers south of Vienna, the 18-hole golf course is set in a lush natural setting and challenges players with its numerous bunkers and water hazards. The design of the golf course provides players with a top-class, international golfing experience. The course opened for play in 1996 and, from 2006 to 2009, hosted the European Tour in Austria and has since been considered one of the best golfing locations in Austria and Europe.

LENGENFELD GOLF CLUB

Lengenfeld features a 36-hole golf course which offers an unforgettable golfing experience amongst the terraced vineyard of a UNESCO World Cultural Landscape. It is divided into the Kamptal course and the Donauland course. While the hilly terrain and many water hazards of the Kamptal course allow long tees, the Donauland course presents a more athletic challenge with its slanted areas and narrow first 9 fairways.

QUELLNESS GOLF RESORT/ BECKENBAUER GOLF COURSE

Picturesquely situated in the peaceful Bavarian countryside, the Quellness Golf Resort features the distinguished, 18-hectar Beckenbauer Golf Course, a championship course designed by renowned golfer Bernhard Lange. The course has been praised by some of the world's foremost players for its technical challenges as well as its impeccable condition.

REGENSBURG GOLF CLUB

At the foothills of the majestic Bavarian Forest, the grounds boast a clubhouse dating back to 1885, trees of up to 300 years old and offer spectacular views of the Danube valley. The undulating terrain and the water hazards present both a challenge to players as well as a feast of natural beauty.

Fontana Golf Club



Cruise fares

per person in EUR based on double occupancy of a cabin

TOUR DATE	VESSEL	CABIN TYPE & DECKS					
		C-4 Haydn	C-1 Haydn	B-4 Strauss	B-1 Strauss	A-1 Mozart	Suite Mozart
8 days Budapest – Passau							
16.10. – 23.10.	AMADEUS Riva	3.479	3.799	4.199	4.449	4.759	5.369

Early booking discount of 15% on the above-mentioned prices when booked by **Nov 30, 2023**. This cruise departure is also offered as cruise-only option. Golf package (€ 1.400 per person) is optionally added to the regular cruise itinerary, page 58.

Single cabin supplement per person for all dates:
C-4+C-1: 15%, B-4: 30%, B-1: 50%, A-1: 60%, Suite: 100% of cruise price.

For cruise price inclusions, see page 16, for deck plans see page 123.

Excursions

prices per person in EUR

"Sound of Vienna" classical concert (Cat. B)	incl.
Full-day trip to Lengenfeld Golf Club (minimum 10 participants)* or Dürnstein walking tour with wine tasting*	164 incl.
Melk Abbey – A Baroque Jewel	61
Full-day trip to Regensburg Golf Club (minimum 10 participants)* or Regensburg walking tour*	175 incl.
Danube Gorge, Weltenburg Abbey and beer tasting* or Thurn & Taxis Palace, brewery with tasting*	78 76

*Excursion operate at the same time, only one may be booked. Please refer to pages 132 – 147 for specific shore excursion details.

Transfers

prices per person in EUR

Budapest: train station – vessel	31	Passau: vessel – train station	28
Budapest: airport – vessel	55	Passau: vessel – airport Munich	109

Golf Inclusions

- 4 rounds of golf at top golf courses
- Green fees, reserved & pre-paid tee times, driving range balls
- Shared electric golf carts (subject to availability)
- Transfer from ship to golf club and return to ship
- Lunch box (on request)
- Ship crew assistance with golf bags from/to cabin (on request)
- Services of an experienced golf expert and tour leader
- Selected excursions as outlined in the itinerary (included)

Participants: min. 20, max. 40 persons





Golf Cruises on the Seine

8 days | Paris – Le Havre – Paris

Golf d'Étretat: A marine golf course at the top of the cliffs

Your itinerary

DAY/PORT	ARR	DEP	HIGHLIGHTS OF THE PROGRAM
1 Paris		20:00	Embarkation from 4 pm Welcome Cocktail and Welcome Dinner Briefing on all golf clubs and starting times
2 Conflans-Ste.-Honorine	01:30	17:00	• Morning transfer and round of golf at Aigle Course/Le Golf National
3 Rouen	08:00	17:30	• Rouen walking tour in the morning (included)* or Round of golf at Champ de Bataille Golf Club (full-day trip, optional)* or Pressoir d'Or and free time in Lyons-la-Forêt in the afternoon (optional)*
4 Le Havre	03:30		• Morning transfer and round of golf at Golf d'Étretat Chanson singers on board
5 Le Havre		09:00	• Morning transfer and round of golf at Barrière de Deauville Golf Club (Rejoin the ship)
Caudebec-en-Caux	15:00	22:00	
6 Les Andelys	08:00	09:00	• Morning transfer and round of golf at Albatros Course/Le Golf National (Rejoin the ship)
Mantes-la-Jolie	17:30	18:30	
7 Paris	03:30		• Paris – Cafés, Cathedrals & City of Light in the morning (included) • Montmartre walking tour in the afternoon (opt.) Captain's Gala Dinner
8 Paris			Disembarkation after breakfast

Excursions are listed in blue. *Excursion operate at the same time, only one may be booked. Please refer to pages 132 – 147 for specific shore excursion details. Golf package for a minimum of 20 participants and a maximum of 40.

We reserve the right to make amendments to the timetable and program.

Price per person in double cabin from **3.889,-** €

Travel on the romantic Seine from Paris to Normandy and back, enjoying a stress-free golf vacation with exceptional service and great golf at some of Europe's most spectacular venues. This itinerary offers golf at four different courses, which are nestled amid stunning scenery, with guaranteed tee times, transportation, green fees, shared golf carts, culture, sightseeing and fine dining included. Throughout the cruise, enjoy the services and in-depth knowledge of our golf expert.

The Golf Clubs

LE GOLF NATIONAL/AIGLE COURSE
Situating near the renowned Palace of Versailles, this is a club no golf enthusiast should miss. Architects Hubert Chesneau and Robert von Hagge transformed the initially flat landscape into one of France's most popular and iconic golfing destinations, home of the Open de France and to the Ryder Cup in 2018. Its 18-hole Aigle course has a traditional links style feel to it and features undulating fairways, meticulously manicured greens and flowing roughs. The contoured fairways can be deceptive and sure to offer challenges for golfers of all handicap levels.

CHAMP DE BATAILLE GOLF CLUB*
This woodland championship course was designed in 1990 by American architect Robin Nelson and French landscape gardener Thierry Huau, who made sure that it follows the natural valleys and water hazards of the estate, featuring centuries-old trees, lakes and clusters of rhododendrons. Ranked among the top 25 finest golf courses in France, it stretches across 370 acres of

historic forest and parkland. The narrow woodland course and the natural water hazards require skill and concentration, offering golfers plenty of technical challenges. Optional golf club trip can be booked until 1 month before departure.

GOLF D'ÉTRETAT

The club is over 100 years old and was founded in 1908 by Englishmen. The original 13-hole course was designed by Julien Chantepie and Arnaud Massy (the only Frenchman to have won the Open). Didier Fruchet revised the layout in the 1990s and today the resort extends over 6,000 meters.

The 18-hole course will test every facet of players' games, particularly with the exciting sequence of holes at the back nine, between the 10th and the 14th, where the fairways run along the cliff edge.

BARRIÈRE DE DEAUVILLE GOLF CLUB

The Club opened in 1929 and offers stunning views of the sea and the surrounding Normandy countryside, while presenting technical challenges that will test even experienced players, particularly on Cotton's Bleu course, with par 36, which is characterized by its green speed and many bunkers. Its three 9-hole courses, with a mix of tree-lined and open parkland holes, stretching across rolling terrain, were designed by architects Tom Simpson and Henry Cotton.

LE GOLF NATIONAL/ALBATROS COURSE

The championship Albatros course is considered one of the best in Europe and was host venue for the Ryder Cup 2018. Players can expect a course that offers plenty of risk/reward situations, with undulating fairways and links-style bunkers, and can look forward to the challenging water hazards that surround the final four holes. The Albatros course masterfully combines a traditional links feel with the modern features of target golf.

Le Golf National



Cruise fares

per person in EUR based on double occupancy of a cabin

TOUR DATE	VESSEL	CABIN TYPE & DECKS					
8 days Paris – Le Havre – Paris		C-4* Haydn	C-1 Haydn	B-4 Strauss	B-1 Strauss	A-1 Mozart	Suite Mozart
02.10. – 09.10.	AMADEUS Diamond	3.889	4.249	4.669	4.929	5.569	5.889

Early booking discount of 15% on the above-mentioned prices when booked by **Nov 30, 2023**. This cruise departure is also offered as cruise-only option. Golf package (€ 1.700 per person) is optionally added to the regular cruise itinerary, page 84.

Single cabin supplement per person for all dates: C-4+C-1: 15%, B-4: 30%, B-1: 50%, A-1: 60%, Suite: 100% of cruise price. *True single cabins with no single supplement available on *AMADEUS Diamond* at the price of C-4 cabins.

For cruise price inclusions, see page 16, for deck plans see page 131.

Excursions

prices per person in EUR

Rouen walking tour	incl. 208
or Full-day trip to Champ de Bataille Golf Club (minimum 10 participants)* or Pressoir d'Or and free time in Lyons-la-Forêt*	79
Paris – Cafés, Cathedrals & City of Light	incl.
Montmartre walking tour	67

*Excursion operate at the same time, only one may be booked. Please refer to pages 132 – 147 for specific shore excursion details.

Transfers

prices per person in EUR

Paris: airport (CDG) – vessel or v.v.	67
Paris: airport (CDG) – hotel or v.v.	67

Golf Inclusions

- 4 rounds of golf at top golf courses
- Green fees, reserved & pre-paid tee times, driving range balls
- Shared electric golf carts (subject to availability)
- Transfer from ship to golf club and return to ship
- Lunch box (on request)
- Ship crew assistance with golf bags from/to cabin (on request)
- Services of an experienced golf expert and tour leader
- Selected excursions as outlined in the itinerary (included)

Participants: min. 20, max. 40 persons





Winter Cruises 100 – 117

RHINE · DANUBE

Magic of Advent	102 – 109
Christmas Cruises	110 – 113
New Year's Eve Cruises.....	114 – 117



Magic of Advent on the Rhine & Main

7 days | Strasbourg – Nuremberg

Cologne: The Christmas market at the cathedral offers culinary variety as well as the magnificent backdrop of Cologne Cathedral.

Your itinerary

STRASBOURG – NUREMBERG

DAY/PORT	ARR	DEP	HIGHLIGHTS OF THE PROGRAM
1 Strasbourg		23:00	Embarkation from 4 pm Welcome Cocktail and Welcome Dinner
2 Speyer Mannheim	07:00 14:00	12:00 23:59	<ul style="list-style-type: none"> • Speyer walking tour with Christmas market • Heidelberg Castle and Christmas market
3 Mainz Frankfurt	04:00 17:00	11:00 22:30	<ul style="list-style-type: none"> • Mainz walking tour with Gutenberg Museum • Evening excursion to Frankfurt with visit to an apple farm and tasting
4 Miltenberg Wertheim	13:00 18:30	14:00 19:00	<ul style="list-style-type: none"> • Miltenberg walking tour with gingerbread and Wertheim walking tour (Rejoin the ship)
5 Würzburg	08:30	17:30	<ul style="list-style-type: none"> • Würzburg with visit to the Residence and wine tasting • Medieval Rothenburg ob der Tauber
6 Bamberg	15:00	19:00	<ul style="list-style-type: none"> • Bamberg walking tour Captain's Gala Dinner
7 Nuremberg	05:00		Disembarkation after breakfast

Excursions listed in blue are not included in the cruise price.
Please refer to pages 132 – 147 for specific shore excursion details.
We reserve the right to make amendments to the timetable and program.

Price per person in double cabin from **999,-** €

Make the most of the advent season with this festive seasonal cruise! From Strasbourg in France, cruise along the legendary Rhine River to Speyer, one of Germany's oldest towns, visit Mannheim, situated at the confluence of the Rhine and Neckar rivers, and discover Mainz, capital of the beautiful Rhineland-Palatinate region of Germany, where you can try local delicacies or visit the Gutenberg museum. Travel along the Main River to the commercial hub Frankfurt and onward to the romantic, medieval towns of Miltenberg and Wertheim. Finally, wrap up your cruise with a stop in Würzburg, located in the midst of the Franconian wine-growing district, and Bamberg, one of Germany's most beautiful towns.

Cruise fares

per person in EUR based on double occupancy of a cabin

TOUR DATE	VESSEL	CABIN TYPE & DECKS					
		C-4 Haydn	C-1 Haydn	B-4 Strauss	B-1 Strauss	A-1 Mozart	Suite Mozart
7 days Strasbourg – Nuremberg							
02.12. – 08.12.	AMADEUS Star	999	1.279	1.589	1.739	1.979	2.429

Early booking discount of 15% on the above-mentioned prices when booked by Nov 30, 2023.
Single cabin supplement per person for all dates:
C-4+C-1: 15%, B-4: 30%, B-1: 50%, A-1: 60%, Suite: 100% of cruise price.
For cruise price inclusions, see page 16, for deck plans see page 126.

Excursion packages

prices per person in EUR and if booked in advance

Cruise Strasbourg – Nuremberg	UP	A	B
Speyer walking tour with Christmas market	29	●	●
Heidelberg Castle and Christmas market	64		●
Mainz walking tour with Gutenberg Museum	24	●	●
Evening excursion to Frankfurt with visit to an apple farm & tasting	79		●
Miltenberg walking tour with gingerbread & Wertheim walking tour	50	●	●
Würzburg with visit to the Residence and wine tasting	69	●	●
Medieval Rothenburg ob der Tauber	45		●
Bamberg walking tour	34	●	●
Excursion packages with 15% discount*		175	335

*compared to the unit price (UP) on board.
Package A with 5 excursions and Package B with 8 excursions.
Please refer to pages 132 – 147 for specific shore excursion details.

Transfers

prices per person in EUR

Nuremberg: vessel – train station	75
Nuremberg: vessel – airport	75



Heidelberg, Christmas market

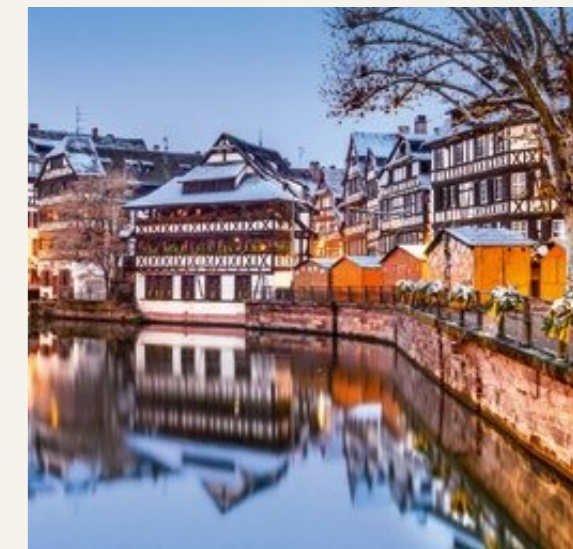

Strasbourg, Petite France

After the excursions, enjoy your time on board





Magic of Advent on the Rhine

5 days | Strasbourg – Cologne or Cologne – Strasbourg

Strasbourg: The charming „Petite France“ with white winter dress

Your itinerary

STRASBOURG – COLOGNE

DAY/PORT	ARR	DEP	HIGHLIGHTS OF THE PROGRAM
1 Strasbourg			Embarkation from 4 pm Welcome Cocktail and Welcome Dinner
2 Strasbourg		22:00	<ul style="list-style-type: none"> • Wintry Alsace and Obernai • Strasbourg with visit to the Christmas market
3 Speyer	05:00	20:00	<ul style="list-style-type: none"> • Heidelberg Castle and Christmas market • Speyer walking tour with Christmas market
4 Rüdesheim	05:00	11:00	<ul style="list-style-type: none"> • Rüdesheim with Music Cabinet Museum
			Cruise through the Upper Middle Rhine Valley Mulled Wine Party on board
Koblenz	15:30	21:59	<ul style="list-style-type: none"> • Koblenz walking tour
			Captain's Gala Dinner
5 Cologne	04:00		Disembarkation after breakfast

Your itinerary

COLOGNE – STRASBOURG

DAY/PORT	ARR	DEP	HIGHLIGHTS OF THE PROGRAM
1 Cologne		22:00	Embarkation from 4 pm Welcome Cocktail and Welcome Dinner
2 Koblenz	07:00	11:00	<ul style="list-style-type: none"> • Koblenz walking tour
			Mulled Wine Party on board
Rüdesheim	17:00	22:00	<ul style="list-style-type: none"> • Rüdesheim with Music Cabinet Museum
3 Speyer	08:00	19:30	<ul style="list-style-type: none"> • Heidelberg Castle and Christmas market • Speyer walking tour with Christmas market
4 Strasbourg	07:30		<ul style="list-style-type: none"> • Wintry Alsace and Obernai • Strasbourg with visit to the Christmas market
			Captain's Gala Dinner
5 Strasbourg			Disembarkation after breakfast

Excursions listed in blue are not included in the cruise price.
We reserve the right to make amendments to the timetable and program.

Experience the pre-Christmas magic of the Rhine by diving into this unique and contemplative travel experience! Commencing in Strasbourg, our advent cruise will take you through the romantic Middle Rhine Valley and to the imposing Rhine metropolis of Cologne, which is as fascinating in winter as in any other season.
Or explore dreamy towns and shore landscapes along the Rhine from Cologne to Strasbourg – the 'Capitale de Noel'.
During the course of the cruises, you visit the most beautiful Christmas markets of the region and discover magical destinations along the riverbanks, aglow with Christmas charm. Relax and enjoy this most peaceful time of the year on board the Amadeus fleet with us.

Price per person in double cabin from **699,-** €

Please refer to pages 132 – 147 for specific shore excursion details.

Cruise fares per person in EUR based on double occupancy of a cabin

TOUR DATE	VESSEL	CABIN TYPE & DECKS					
		C-4 Haydn	C-1 Haydn	B-4 Strauss	B-1 Strauss	A-1 Mozart	Suite Mozart
5 days Strasbourg – Cologne							
01.12. – 05.12.	AMADEUS Riva	739	929	1.159	1.259	1.439	1.769
13.12. – 17.12.	AMADEUS Riva	699	899	1.099	1.199	1.369	1.689
5 days Cologne – Strasbourg							
09.12. – 13.12.	AMADEUS Riva	739	929	1.159	1.259	1.439	1.769

Early booking discount of 15% on the above-mentioned prices when booked by Nov 30, 2023.
Single cabin supplement per person for all dates:
C-4 + C-1: 15%, B-4: 30%, B-1: 50%, A-1: 60%, Suite: 100% of cruise price.
For cruise price inclusions, see page 16, for deck plans see page 123.

Excursion packages prices per person in EUR and if booked in advance

Cruises Strasbourg – Cologne and Cologne – Strasbourg	UP	A	B
Wintry Alsace and Obernai	78		•
Strasbourg with visit to the Christmas market	76	•	•
Heidelberg Castle and Christmas market	64	•	•
Speyer walking tour with Christmas market	29		•
Rüdesheim with Music Cabinet Museum	33	•	•
Koblenz walking tour	24	•	•
Excursion packages with 15% discount*		167	258

*compared to the unit price (UP) on board.
Package A with 4 excursions and Package B with 6 excursions.
Please refer to pages 132 – 147 for specific shore excursion details.

Transfers prices per person in EUR

Cologne: train station – vessel or v.v.	36
Cologne: airport – vessel or v.v.	46



Koblenz



Typical Nutcrackers

Restaurant: Festively decorated





Magic of Advent on the Danube

7 days | Vienna – Nuremberg

From mid-November until Christmas, Vienna's most beautiful squares are once again transformed into magical Christmas markets.

Your itinerary

VIENNA – NUREMBERG

DAY/PORT	ARR	DEP	HIGHLIGHTS OF THE PROGRAM
1 Vienna			Embarkation from 4 pm Welcome Cocktail and Welcome Dinner
2 Vienna		22:30	<ul style="list-style-type: none"> • Vienna – Imperial discovery tour • Visit to Schönbrunn Palace and Christmas market • "Sound of Vienna" classical concert (Cat. B)
3 Emmersdorf	08:30	14:00	<ul style="list-style-type: none"> • Melk Abbey – A Baroque Jewel Mulled Wine Party on board
4 Passau	08:30	16:00	<ul style="list-style-type: none"> • Passau walking tour and organ concert in the Cathedral Visit the Christmas market in Passau
5 Regensburg	09:00	21:00	<ul style="list-style-type: none"> • Regensburg walking tour • Thurn & Taxis Palace and Christmas market
6 Roth Nuremberg	13:00 17:00	13:30	<ul style="list-style-type: none"> • Nuremberg with visit to the Christmas market Captain's Gala Dinner
7 Nuremberg			Disembarkation after breakfast

Excursions listed in blue are not included in the cruise price. Please refer to pages 132 – 147 for specific shore excursion details. We reserve the right to make amendments to the timetable and program.

At this most contemplative time of year, you can enter a real winter fairytale. Visit the best Christmas Markets along the Danube, including the visit of the Christmas Markets at Palais "Thurn und Taxis" and a mulled wine party in the famous winegrowing region of Wachau! Explore sleepy little towns and riverscapes, warm yourself with a delicious glass of mulled wine on board... enjoy the pre-Christmas period.

Price per person in double cabin from **999,-** €

Cruise fares

per person in EUR based on double occupancy of a cabin

TOUR DATE	VESSEL	CABIN TYPE & DECKS					
		C-4 Haydn	C-1 Haydn	B-4 Strauss	B-1 Strauss	A-1 Mozart	Suite Mozart
7 days Vienna – Nuremberg							
28.11. – 04.12.	AMADEUS Cara	1.049	1.339	1.669	1.809	2.059	2.529
10.12. – 16.12.	AMADEUS Cara	999	1.269	1.579	1.719	1.959	2.409

Early booking discount of 15% on the above-mentioned prices when booked by **Nov 30, 2023**.
Single cabin supplement per person for all dates:
C-4+C-1: 15%, B-4: 30%, B-1: 50%, A-1: 60%, Suite: 100% of cruise price.
For cruise price inclusions, see page 16, for deck plans see page 124.

Excursion packages

prices per person in EUR and if booked in advance

Cruise Vienna – Nuremberg	UP	A	B
Vienna – Imperial discovery tour	46	●	●
Visit to Schönbrunn Palace and Christmas market	67		●
"Sound of Vienna" classical concert (Cat. B)	73		●
Melk Abbey – A Baroque Jewel	61	●	●
Passau walking tour and organ concert in the Cathedral	30	●	●
Regensburg walking tour	24	●	●
Thurn & Taxis Palace and Christmas market	76		●
Nuremberg with visit to the Christmas market	52	●	●
Excursion packages with 15% discount*		181	365

*compared to the unit price (UP) on board.
Package A with 5 excursions and Package B with 8 excursions.
Please refer to pages 132 – 147 for specific shore excursion details.

Transfers

prices per person in EUR

Vienna: airport – vessel	40	Nuremberg: vessel – train station	75
Vienna: train station – vessel	34	Nuremberg: vessel – airport	75
Vienna: city center – vessel	34	Nuremberg: vessel – city center	75



Perfect service



AMADEUS Cara: Beautiful decoration

Passau in wintertime





Magic of Advent on the Danube

7 days | Nuremberg – Vienna

The Nuremberg Christkindlesmarkt is one of the oldest and most famous Christmas Markets in the world.

Your itinerary

NUREMBERG – VIENNA

DAY/PORT	ARR	DEP	HIGHLIGHTS OF THE PROGRAM
1 Nuremberg			Embarkation from 4 pm Welcome Cocktail and Welcome Dinner
2 Nuremberg		13:00	• Nuremberg with visit to the Christmas market
3 Regensburg	09:00	21:00	• Regensburg walking tour • Thurn & Taxis Palace and Christmas market
4 Passau	09:00	15:30	• Passau walking tour and organ concert in the Cathedral Visit the Christmas market in Passau
5 Emmersdorf	08:00	12:30	• Melk Abbey – A Baroque Jewel Mulled Wine Party on board
Vienna	18:30		• "Sound of Vienna" classical concert (Cat. B)
6 Vienna			• Vienna – Imperial discovery tour • Visit to Schönbrunn Palace Captain's Gala Dinner
7 Vienna			Disembarkation after breakfast

Excursions listed in blue are not included in the cruise price.
Please refer to pages 132 – 147 for specific shore excursion details.
We reserve the right to make amendments to the timetable and program.

At this most contemplative time of year, you can enter a real winter fairytale. Visit the best Christmas Markets along the Danube, including the visit of the Christmas Markets at Palais "Thurn und Taxis" and a mulled wine party in the famous winegrowing region of Wachau! Explore sleepy little towns and riverscapes, warm yourself with a delicious glass of mulled wine on board... enjoy the pre-Christmas period.

Price per person in double cabin from **999,-** €

Cruise fares

per person in EUR based on double occupancy of a cabin

TOUR DATE	VESSEL	CABIN TYPE & DECKS					
		C-4 Haydn	C-1 Haydn	B-4 Strauss	B-1 Strauss	A-1 Mozart	Suite Mozart
7 days Nuremberg – Vienna							
14.12. – 20.12.	AMADEUS Queen	999	1.269	1.579	1.719	1.959	2.409

Early booking discount of 15% on the above-mentioned prices when booked by Nov 30, 2023.
Single cabin supplement per person for all dates:
C-4 + C-1: 15%, B-4: 30%, B-1: 50%, A-1: 60%, Suite: 100% of cruise price.
For cruise price inclusions, see page 16, for deck plans see page 127.

Excursion packages

prices per person in EUR and if booked in advance

Cruise Vienna – Nuremberg	UP	A	B
Nuremberg with visit to the Christmas market	52	•	•
Regensburg walking tour	24	•	•
Thurn & Taxis Palace and Christmas market	76		•
Passau walking tour and organ concert in the Cathedral	30	•	•
Melk Abbey – A Baroque Jewel	61	•	•
"Sound of Vienna" classical concert (Cat. B)	73		•
Vienna – Imperial discovery tour	46	•	•
Visit to Schönbrunn Palace	67		•
Excursion packages with 15% discount*		181	365

*compared to the unit price (UP) on board.
Package A with 5 excursions and Package B with 8 excursions.
Please refer to pages 132 – 147 for specific shore excursion details.

Transfers

prices per person in EUR

Nuremberg: train station – vessel	75	Vienna: vessel – airport	40
Nuremberg: airport – vessel	75	Vienna: vessel – train station	34
Nuremberg: city center – vessel	75	Vienna: vessel – city center	34



Wintry Vienna



Sweets delights

Mulled wine





Christmas Cruise on the Rhine

7 days | Cologne – Strasbourg – Cologne

Cologne: After visiting the most beautiful town by night, enjoy your time on board.

Your itinerary

COLOGNE – STRASBOURG – COLOGNE

DAY/PORT	ARR	DEP	HIGHLIGHTS OF THE PROGRAM
1 Cologne		22:00	Embarkation from 4 pm Welcome Cocktail and Welcome Dinner
2 Koblenz	08:00	12:00	• Koblenz walking tour Passage of the Lorelei in the afternoon
3 Speyer	06:00		• Speyer walking tour & the Imperial Cathedral Christmas party on board Attend Christmas mass in the Dome of Speyer (included)
4 Speyer Strasbourg		01:30 12:30 22:00	• Strasbourg with canal boat tour
5 Mainz	12:00	22:00	• Mainz walking tour with Gutenberg Museum
6 Cologne	08:00		• Cologne walking tour and Kölsch tasting Captain's Gala Dinner
7 Cologne			Disembarkation after breakfast

Excursions listed in blue are not included in the cruise price. Please refer to pages 132 – 147 for specific shore excursion details. We reserve the right to make amendments to the timetable and program.

Celebrate Christmas in a new way – on board our festively decorated AMADEUS cruise ship. Experience a special Christmas atmosphere – be enchanted by the local Christmas markets with their smells of gingerbread and Gluhwein, where traditional handicrafts meet sweet memories of childhood. On Christmas day, the restaurant will prepare a special gourmet dinner, after which you will have the option of attending a traditional midnight mass.

Price per person in double cabin from **1.099,-** €

Cruise fares

per person in EUR based on double occupancy of a cabin

TOUR DATE	VESSEL	CABIN TYPE & DECKS					
		C-4 Haydn	C-1 Haydn	B-4 Strauss	B-1 Strauss	A-1 Mozart	Suite Mozart
7 days Cologne – Strasbourg – Cologne							
22.12. – 28.12.	AMADEUS Imperial	1.099	1.399	1.739	1.899	2.159	2.659

Early booking discount of 15% on the above-mentioned prices when booked by **Nov 30, 2023**.
Single cabin supplement per person for all dates:
C-4 + C-1: 15%, B-4: 30%, B-1: 50%, A-1: 60%, Suite: 100% of cruise price.
For cruise price inclusions, see page 16, for deck plans see page 125.

Excursion packages

prices per person in EUR and if booked in advance

Cruise Cologne – Strasbourg – Cologne	UP	A	B
Koblenz walking tour	24	•	•
Speyer walking tour & the Imperial Cathedral	29	•	•
Strasbourg with canal boat tour	76	•	•
Mainz walking tour with Gutenberg Museum	24	•	•
Cologne walking tour and Kölsch tasting	44	•	•
Excursion packages with 15% discount*		147	167

*compared to the unit price (UP) on board.
Package A with 4 excursions and Package B with 5 excursions.
Please refer to pages 132 – 147 for specific shore excursion details.

Transfers

prices per person in EUR

Cologne: train station – vessel or v.v.	36
Cologne: airport – vessel or v.v.	46

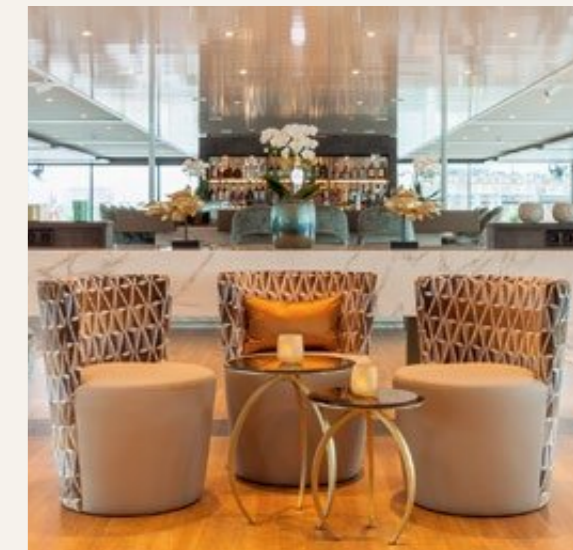

AMADEUS Imperial: Panorama-Bar



Atmospheric time onboard

Refreshing treats after dinner





Christmas Cruise on the Danube

7 days | Passau – Bratislava – Passau

The Old Town of Salzburg is a UNESCO World Cultural Heritage Site, with charming passages and idyllic corners.

Your itinerary

PASSAU – BRATISLAVA – PASSAU

DAY/PORT	ARR	DEP	HIGHLIGHTS OF THE PROGRAM
1 Passau			Embarkation from 4 pm Welcome Cocktail and Welcome Dinner
2 Passau		10:30	<ul style="list-style-type: none"> • Passau walking tour** or Full-day Salzburg incl. Salzkammergut, lunch and Christmas market
Linz	17:30	20:00	Visit to the Christmas market in Linz (included)
3 Emmersdorf Dürnstein	06:00 15:00	13:00	<ul style="list-style-type: none"> • Melk Abbey – A Baroque Jewel Christmas Celebration on board (included) Visit to the Christmas Mass in Dürnstein (included)
4 Dürnstein Vienna		02:00 08:00	<ul style="list-style-type: none"> • Vienna – Imperial discovery tour • Visit to Schönbrunn Palace
5 Vienna Bratislava		03:00 08:00	<ul style="list-style-type: none"> • Bratislava – Beauty on the Danube
6 Linz	13:30	22:00	<ul style="list-style-type: none"> • Linz walking tour with Linzer Torte tasting Captain's Gala Dinner
7 Passau	08:00		Disembarkation after breakfast

Excursions listed in blue are not included in the cruise price.

**not bookable together with the Full-day Salzburg with lunch. Please refer to pages 132 – 147 for specific shore excursion details. We reserve the right to make amendments to the timetable and program.

Price per person in double cabin from **1.079,-** €

Christmas is such a great reason for gathering and feeling connected! Celebrate Christmas in a whole new way – on board our festively decorated AMADEUS cruise ship. Dreamy villages gleam and river capitals such as Vienna and Bratislava beckon with a cheerful welcome.

Enjoy Christmas stories, decorating the Christmas tree, and a joyous celebration on board. On Christmas Eve, join a traditional mass in charming Dürnstein on the banks of the Danube.

Cruise fares

per person in EUR based on double occupancy of a cabin

TOUR DATE	VESSEL	CABIN TYPE & DECKS					
		C-4 Haydn	C-1 Haydn	B-4 Strauss	B-1 Strauss	A-1 Mozart	Suite Mozart
7 days Passau – Bratislava – Passau							
22.12. – 28.12.	AMADEUS Queen	1.079	1.369	1.709	1.859	2.119	2.599

Early booking discount of 15% on the above-mentioned prices when booked by Nov 30, 2023.

Single cabin supplement per person for all dates:

C-4 + C-1: 15%, B-4: 30%, B-1: 50%, A-1: 60%, Suite: 100% of cruise price.

For cruise price inclusions, see page 16, for deck plans see page 127.

Excursion packages

prices per person in EUR and if booked in advance

Cruise Passau – Bratislava – Passau	UP	A	B
Passau walking tour	24	•	•
or Full-day Salzburg incl. Salzkammergut, lunch & Christmas market	125	•	•
Melk Abbey – A Baroque Jewel	61	•	•
Vienna – Imperial discovery tour	46	•	•
Visit to Schönbrunn Palace	67	•	•
Bratislava – Beauty on the Danube	45	•	•
Linz walking tour with Linzer Torte tasting	27	•	•
Excursion packages with 15% discount*		173	315

*compared to the unit price (UP) on board.

Package A with 5 excursions and Package B with 6 excursions.

Please refer to pages 132 – 147 for specific shore excursion details.

Transfers

prices per person in EUR

Passau: train station – vessel or v.v.	28
Munich airport – vessel/Passau or v.v.	109

Parking place

prices in EUR

Passau: 8 days outdoor parking	98
Passau: 8 days indoor garage	117



The famous Linzer cookies



Festive glow on board your AMADEUS vessel

Bratislava





New Year's Eve Cruise on the Rhine

8 days | Cologne – Basel – Cologne

Basel: Fantastic fireworks await

Your itinerary

COLOGNE – BASEL – COLOGNE

DAY/PORT	ARR	DEP	HIGHLIGHTS OF THE PROGRAM
1 Cologne		17:00	Embarkation from 4 pm Welcome Cocktail and Welcome Dinner
2 Rüdesheim Mainz	08:00 15:00	12:30 18:00	<ul style="list-style-type: none"> • Drosselgasse & tasting of Rüdesheimer coffee • Mainz walking tour with Gutenberg Museum
3 Strasbourg	12:00	18:00	• Strasbourg with canal boat tour
4 Basel	08:00		<ul style="list-style-type: none"> • Basel – Where three countries meet "Dance into the New Year" – Party on board
5 Basel		09:00	Enjoy a relaxing day on board
6 Speyer Mannheim	02:00 14:00	12:00 23:59	<ul style="list-style-type: none"> • Speyer walking tour & the Imperial Cathedral • Romantic Heidelberg with castle ruins
7 Oberwesel Koblenz	07:00 14:00	11:30 22:00	<ul style="list-style-type: none"> • Oberwesel walking tour • Koblenz walking tour Captain's Gala Dinner
7 Cologne	03:00		Disembarkation after breakfast

Excursions listed in blue are not included in the cruise price. Please refer to pages 132 – 147 for specific shore excursion details. We reserve the right to make amendments to the timetable and program.

Price per person in double cabin from **1.429,-** €

Treat yourself to a memorable year-end celebration with a special highlight: an exciting welcome to the New Year will be heralded on board.

Ring in the New Year in style in the river city of Basel, which beckons a grandiose firework display above the Rhine. Be there and enjoy the atmosphere when all the church bells in the city ring in the New Year. View the spectacular fireworks illuminating the sky from the Sun Deck. Next day, relax or explore the old town complete with a bright red Rathaus (Town Hall) building.

Cruise fares

per person in EUR based on double occupancy of a cabin

TOUR DATE	VESSEL	CABIN TYPE & DECKS					
		C-4 Haydn	C-1 Haydn	B-4 Strauss	B-1 Strauss	A-1 Mozart	Suite Mozart
8 days Cologne – Basel – Cologne							
28.12. – 04.01.	AMADEUS Riva	1.429	1.819	2.269	2.459	2.809	3.449
28.12. – 04.01.	AMADEUS Imperial	1.429	1.819	2.269	2.459	2.809	3.449

Early booking discount of 15% on the above-mentioned prices when booked by Nov 30, 2023.

Single cabin supplement per person for all dates:

C-4 + C-1: 15%, B-4: 30%, B-1: 50%, A-1: 60%, Suite: 100% of cruise price.

For cruise price inclusions, see page 16, for deck plans see page 118–131.

Excursion packages

prices per person in EUR and if booked in advance

Cruise Cologne – Basel – Cologne	UP	A	B
Drosselgasse & tasting of Rüdesheimer coffee	33	•	•
Mainz walking tour with Gutenberg Museum	24		•
Strasbourg with canal boat tour	76	•	•
Basel – Where three Countries meet	91	•	•
Speyer walking tour & the Imperial Cathedral	29		•
Romantic Heidelberg with castle ruins	64	•	•
Oberwesel walking tour	24		•
Koblenz walking tour	24	•	•
Excursion packages with 15% discount*		245	310

*compared to the unit price (UP) on board.

Package A with 5 excursions and Package B with 8 excursions.

Please refer to pages 132 – 147 for specific shore excursion details.

Transfers

prices per person in EUR

Cologne: train station – vessel or v.v.	36
Cologne: airport – vessel or v.v.	46



Cologne: Cathedral



Enjoy the Gala Dinner on board

Happy New Year!





© Samuel Adam, Feendlich/Shutterstock.com

New Year's Eve Cruise on the Danube

7 days | Passau – Budapest – Passau

What a magnificent backdrop for fireworks – the Parliament of Budapest

Your itinerary

PASSAU – BUDAPEST – PASSAU

DAY/PORT	ARR	DEP	HIGHLIGHTS OF THE PROGRAM
1 Passau		18:00	Embarkation from 4 pm Welcome Cocktail and Welcome Dinner
2 Vienna	13:00	19:00	• Vienna – Imperial discovery tour
3 Budapest	12:00		• Budapest – Castle Hill & Historic Wonders Evening cruise with folklore show on board "Dance into the New Year" – Party on board
4 Budapest		13:00	Free time in the morning
5 Bratislava	08:00	18:00	• Bratislava – Beauty on the Danube • Schloss Hof – Baroque Palace and Estate
6 Emmersdorf	12:00	17:30	• Melk Abbey – A Baroque Jewel Captain's Gala Dinner
7 Passau	09:30		Disembarkation after breakfast

Excursions listed in blue are not included in the cruise price.
Please refer to pages 132 – 147 for specific shore excursion details.
We reserve the right to make amendments to the timetable and program.

Treat yourself to a memorable year-end celebration with a special highlight: our New Year's party on board. Budapest is one of the world's best cities for celebrating New Year's Eve! After a 5-course gala dinner, we invite you to party with traditional Danube waltzes and spectacular fireworks. Dance into the night and greet the New Year amidst the spectacular scenery of the Budapest Parliament! What a magnificent view of the illuminated building.

Price per person in double cabin from **1.239,-** €

Cruise fares

per person in EUR based on double occupancy of a cabin

TOUR DATE	VESSEL	CABIN TYPE & DECKS					
		C-4 Haydn	C-1 Haydn	B-4 Strauss	B-1 Strauss	A-1 Mozart	Suite Mozart
7 days Passau – Budapest – Passau							
29.12. – 04.01.	AMADEUS Queen	1.239	1.579	1.959	2.139	2.429	2.989

Early booking discount of 15% on the above-mentioned prices when booked by Nov 30, 2023.

Single cabin supplement per person for all dates:
C-4+C-1: 15%, B-4: 30%, B-1: 50%, A-1: 60%, Suite: 100% of cruise price.
For cruise price inclusions, see page 16, for deck plans see page 127.

Excursion packages

prices per person in EUR and if booked in advance

Cruise Passau – Budapest – Passau	UP	A	B
Vienna – Imperial discovery tour	46	•	•
Budapest – Castle Hill & Historic Wonders	45	•	•
Bratislava – Beauty on the Danube	45	•	•
Schloss Hof – Baroque Palace and Estate	67		•
Melk Abbey – A Baroque Jewel	61	•	•
Excursion packages with 15% discount*		167	224

*compared to the unit price (UP) on board.
Package A with 4 excursions and Package B with 5 excursions.
Please refer to pages 132 – 147 for specific shore excursion details.

Transfers

prices per person in EUR

Passau: train station – vessel or v.v.	28
Munich airport – vessel/Passau or v.v.	109

Parking place

prices in EUR

Passau: 8 days outdoor parking	98
Passau: 8 days indoor garage	117



New Year's Eve Celebration



Vienna

Welcome the New Year





The AMADEUS Fleet

Your floating Luxury Hotels

Your Floating Luxury Hotel

PUBLIC AREAS

1 AMADEUS-Club

Relax in the quiet of the AMADEUS-Club. Settle in with a good book, or choose one from the well-stocked library, which also features a selection of board games and puzzles. This area also has a 24-hour self-service hot beverage station with complimentary coffee and tea.



AMADEUS Riva

2 Fitnessraum

The Fitness Room is available 24-hours a day and complete with modern equipment, so you never miss a workout.



AMADEUS Queen

5 "River Terrace" and other outdoor Lounges

The "River Terrace" and other outdoor areas, some encircled by glass railings, ensure you can relish moments of delight with breathtaking views, along with snacks and beverages, while remaining shielded from wind and rain.



AMADEUS Star

6 Lobby with Reception and Gift shop

Visit the onboard gift shop for an assortment of various everyday essentials or the perfect souvenir. You may contact Reception anytime by dialing 9*.



AMADEUS Cara

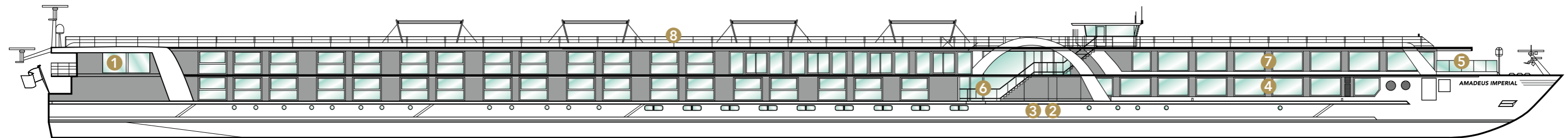

3 Massage Room

Pamper yourself with a relaxing massage. Book a Swedish massage, aromatherapy or foot reflexology at the Reception.



AMADEUS Imperial

4 Panorama-Restaurant

Take advantage of the handsome, single-seating restaurant, serving continental cuisine, together with a selection of locally inspired dishes that change with the season and highlight European gastronomic traditions.



AMADEUS Cara

7 Panorama-Bar and -Lounge

This is one of the most versatile spaces on board, where you may find enthralling entertainment, special highlight dinners, or perhaps simply an elegant place to decompress, drink in hand, while adoring stunning views of the river's shores.



AMADEUS Silver III

8 Sun Deck

Atop ship, the wide-open Sun Deck invites you to lie down and relax in the sun lounges, or play a game of giant chess or shuffleboard.

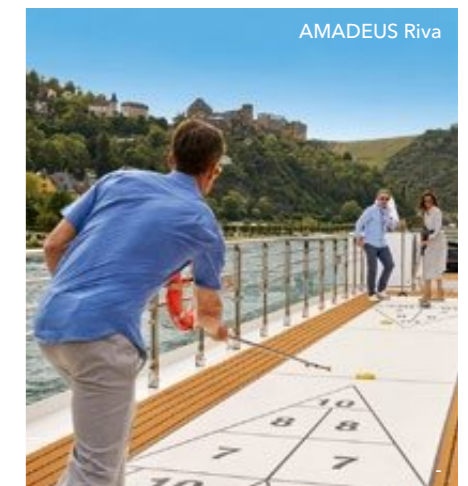

AMADEUS Riva

NEW: AMADEUS NOVA



Stateroom (Rendering)



Heated pool (Rendering)



Rendering



Café Vienna



Restaurant



Suite, Mozart Deck

ONBOARD FACILITIES

- Panorama-Restaurant
- Panorama-Bar and Lounge
- Amadeus-Club
- "Café Vienna" with Viennese coffee specialities
- Outdoor glass-shielded "River Terrace"
- Heated pool
- Sun Deck with Sun Deck Lounge, lounge chairs, shade awnings, Golf Putting Green, giant Chess Board and Shuffleboard
- Fitness Room, Massage Room
- Gift Shop, Laundry Service
- Complimentary bicycles on board
- Wi-Fi available
- Elevator

STATEROOM AMENITIES

- Suites (26,4 m²/284 sq.ft.) on Mozart Deck with comfortable corner sofa, luxurious bathroom and walk-out exterior balcony
- Staterooms (17,5 m²/188 sq.ft.) on Strauss and Mozart Deck with drop-down panoramic windows
- Staterooms (16 m²/172 sq.ft.) on Haydn Deck with smaller panoramic windows (cannot be opened)
- Cabins with connecting doors are available on Strauss Deck on request
- Mini-Bar (all staterooms except categories C-1 and C-4)
- Walk-in wardrobe
- Choice of bed configuration: double or twin bed
- Flat-screen television
- Individual climate control
- Bathrooms with walk-in shower
- Bathrobes in Suites
- Hair dryer
- Direct dial telephone
- In-room safe

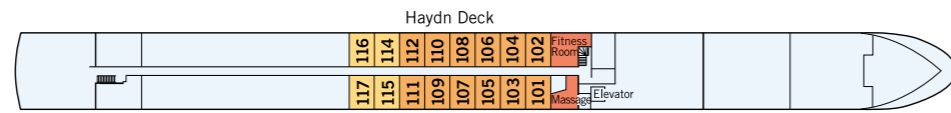
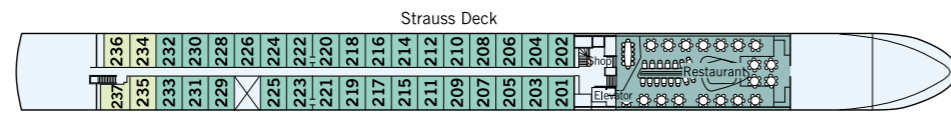
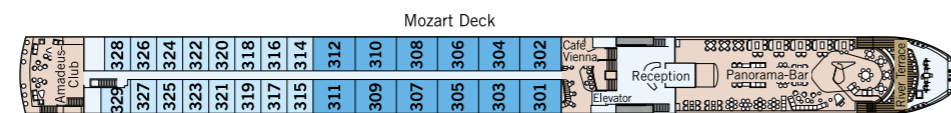
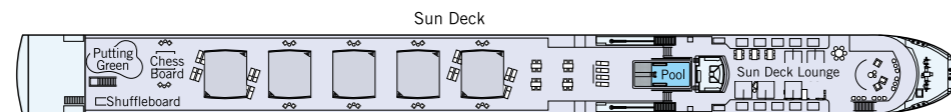
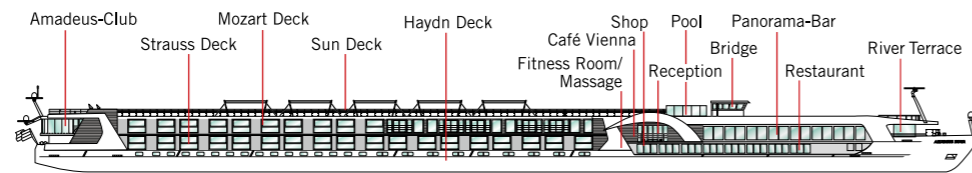

Suite

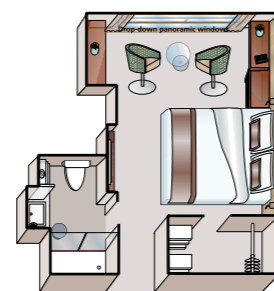

Stateroom, Mozart and Strauss Deck

TECHNICAL DATA

- Built: 2024
- Register: Germany
- Length: 135 m | 443 feet
- Width: 11,4 m | 37,5 feet
- Height above water: 6 m | 19,8 feet
- Speed: 25 km/h | 15,5 mph
- Decks: 4
- Staterooms / Suites: 67/12
- Max. passengers: 158
- Crew members: approx. 46

ONBOARD FACILITIES

- Panorama-Restaurant
- Panorama-Bar and Lounge
- Amadeus-Club
- "Café Vienna" with Viennese coffee specialities
- Outdoor glass-shielded "River Terrace"
- Sun Deck with Sun Deck Lounge, lounge chairs, shade awnings and giant Chess Board
- Fitness Room
- Massage Room
- Gift Shop
- Laundry Service
- Complimentary bicycles on board
- Wi-Fi available
- Elevator

STATEROOM AMENITIES

- Suites (26,4 m²/284 sq.ft.) on Mozart Deck with comfortable corner sofa, luxurious bathroom and walk-out exterior balcony
- Staterooms (17,5 m²/188 sq.ft.) on Strauss and Mozart Deck with drop-down panoramic windows
- Staterooms (16 m²/172 sq.ft.) on Haydn Deck with smaller panoramic windows (cannot be opened)
- Cabins with connecting doors are available on Strauss Deck on request
- Mini-Bar
- Walk-in wardrobe
- Choice of bed configuration: double or twin bed
- Flat-screen television
- Individual climate control
- Bathrooms with walk-in shower
- Bathrobes in Suites
- Hair dryer
- Direct dial telephone
- In-room safe

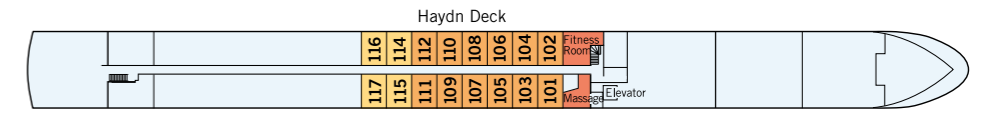
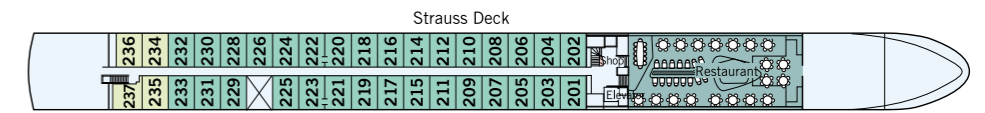
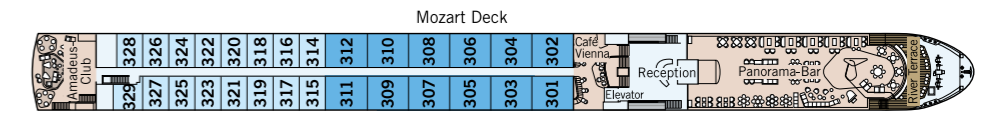
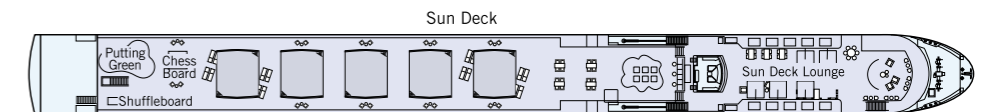
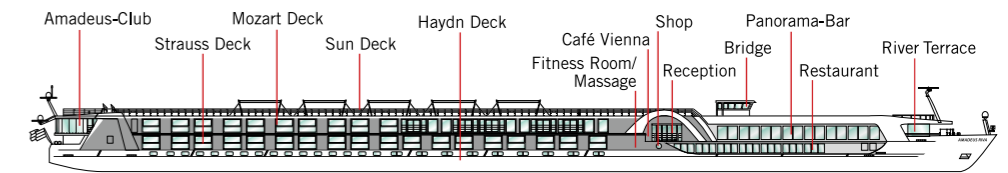

Suite

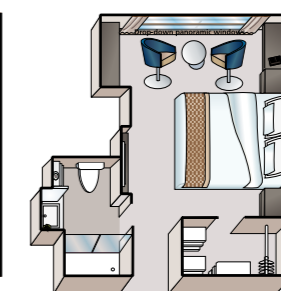

Stateroom, Mozart and Strauss Deck

TECHNICAL DATA

- Built: 2023
- Registry: Germany
- Length: 135 m | 443 feet
- Width: 11,4 m | 37,5 feet
- Height above water: 6 m | 19,8 feet
- Speed: 25 km/h | 15,5 mph
- Decks: 4
- Staterooms/Suites: 67/12
- Max. passengers: 158
- Crew members: approx. 46

AMADEUS CARA



Stateroom, Mozart and Strauss Deck



Panorama-Bar



Suite, Mozart Deck



Stateroom, Mozart and Strauss Deck



Panorama-Lounge



Suite, Mozart Deck

ONBOARD FACILITIES

- Panorama-Restaurant
- Panorama-Bar and Lounge
- Amadeus-Club
- "Café Vienna" with Viennese coffee specialities
- Outdoor glass-shielded "River Terrace"
- Sun Deck with Sun Deck Lounge, lounge chairs, shade awnings, Golf Putting Green, giant Chess Board and Shuffleboard
- Fitness Room, Massage Room
- Gift Shop
- Laundry Service
- Complimentary bicycles on board
- Wi-Fi available
- Elevator

STATEROOM AMENITIES

- Suites (26,4 m²/284 sq.ft.) on Mozart Deck with comfortable corner sofa, luxurious bathroom and walk-out exterior balcony
- Staterooms (17,5 m²/188 sq.ft.) on Strauss and Mozart Deck with drop-down panoramic windows
- Staterooms (16 m²/172 sq.ft.) on Haydn Deck with smaller panoramic windows (cannot be opened)
- Mini-Bar (all staterooms except categories C-1 and C-4)
- Walk-in wardrobe
- Choice of bed configuration: double or twin bed
- Flat-screen television
- Individual climate control
- Bathrooms with walk-in shower
- Bathrobes in Suites
- Hair dryer
- Direct dial telephone
- In-room safe

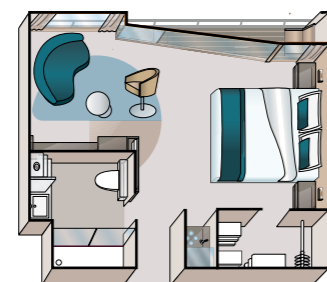
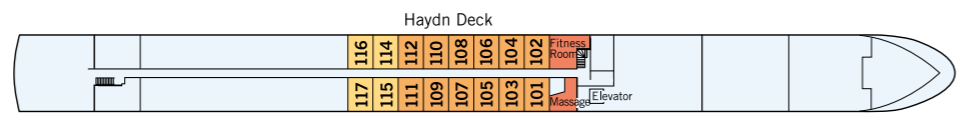
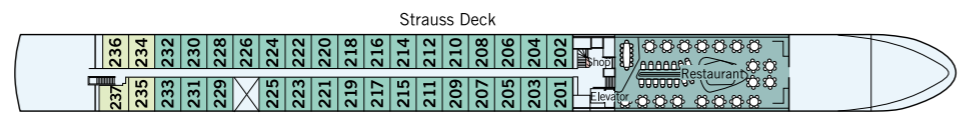
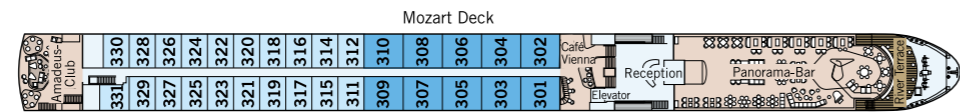
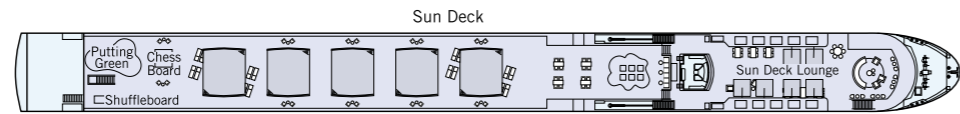
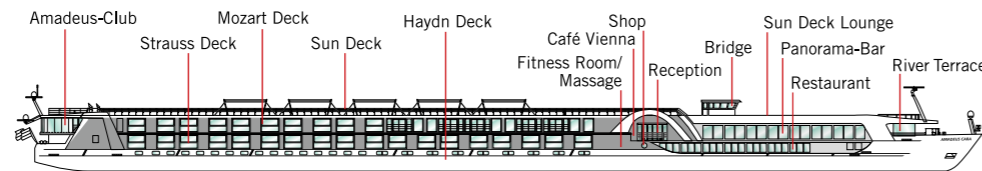

Suite

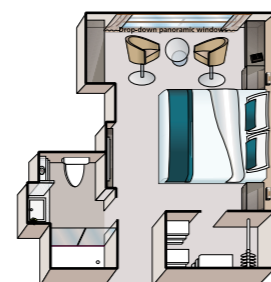

Stateroom, Mozart and Strauss Deck

TECHNICAL DATA

- Built: 2022
- Registry: Germany
- Length: 135 m | 443 feet
- Width: 11,4 m | 37,5 feet
- Height above water: 6 m | 19,8 feet
- Speed: 25 km/h | 15,5 mph
- Decks: 4
- Staterooms/Suites: 71/10
- Max. passengers: 162
- Crew members: approx. 46

AMADEUS IMPERIAL

ONBOARD FACILITIES

- Panorama-Restaurant
- Panorama-Bar and Lounge
- Amadeus-Club
- "Café Vienna" with Viennese coffee specialities
- Outdoor glass-shielded "River Terrace"
- Sun Deck with Lido-Bar, lounge chairs, shade awnings, giant Chess Board and Shuffleboard
- Fitness Room, Massage Room
- Gift Shop
- Laundry Service
- Complimentary bicycles on board
- Wi-Fi available
- Elevator

STATEROOM AMENITIES

- Suites (26,4 m²/284 sq.ft.) on Mozart Deck with comfortable corner sofa, luxurious bathroom and walk-out exterior balcony
- Staterooms (17,5 m²/188 sq.ft.) on Strauss and Mozart Deck with drop-down panoramic windows
- Staterooms (16 m²/172 sq.ft.) on Haydn Deck with smaller panoramic windows (cannot be opened)
- Cabins with connecting doors are available on Haydn Deck on request
- Mini-Bar (all staterooms except categories C-1 and C-4)
- Walk-in wardrobe
- Choice of bed configuration: double or twin bed
- Flat-screen television
- Individual climate control
- Bathrooms with walk-in shower
- Bathrobes in Suites
- Hair dryer
- Direct dial telephone
- In-room safe

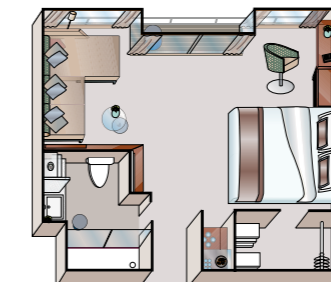
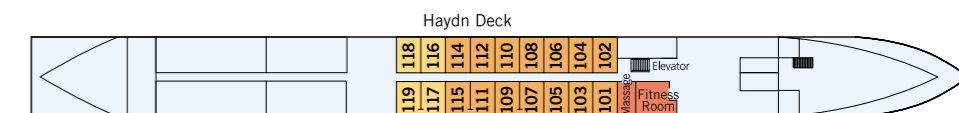
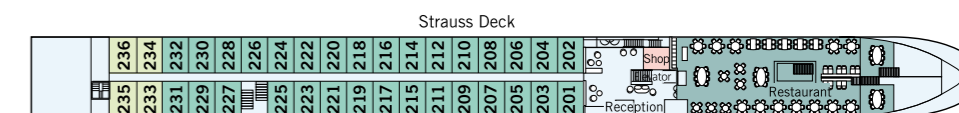
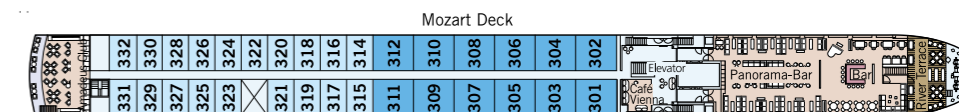
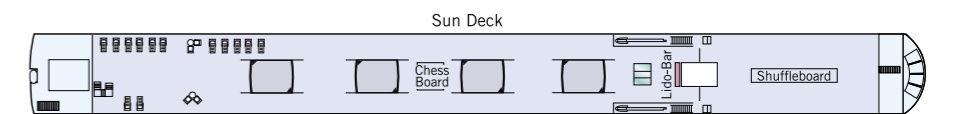
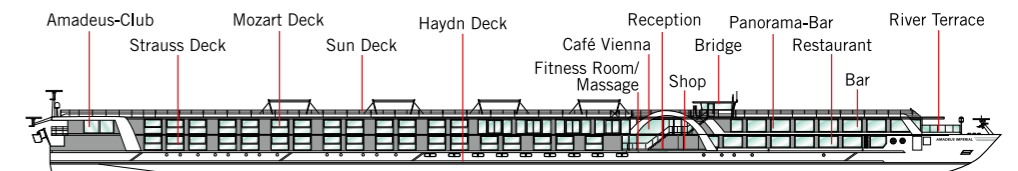

Suite

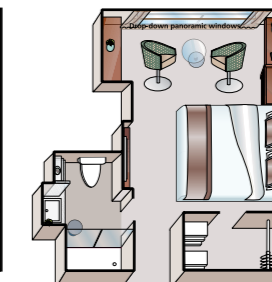

Stateroom, Mozart and Strauss Deck

TECHNICAL DATA

- Built: 2020
- Registry: Germany
- Length: 135 m | 443 feet
- Width: 11,4 m | 37,5 feet
- Draft: 1,45 m | 5 feet
- Height above water: 6 m | 19,8 feet
- Speed: 25 km/h | 15,5 mph
- Decks: 4
- Staterooms/Suites: 72/12
- Max. passengers: 168
- Crew members: approx. 46

AMADEUS STAR

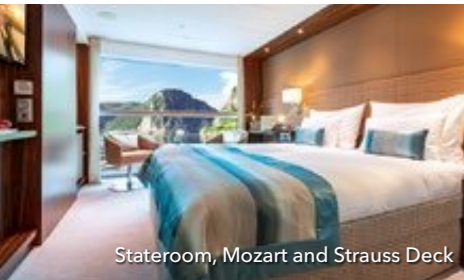

Stateroom, Mozart and Strauss Deck



Amadeus-Club



Suite, Mozart Deck



Stateroom, Mozart and Strauss Deck



Indoor Pool and Amadeus-Club

AMADEUS QUEEN



Suite, Mozart Deck

ONBOARD FACILITIES

- Panorama-Restaurant
- Panorama-Bar and Lounge
- Amadeus-Club and Wine Bar
- Outdoor glass-shielded "River Terrace"
- Sun Deck with Lido-Bar, Stern Terrace, lounge chairs, shade awnings, giant Chess Board and Shuffleboard
- Fitness Room, Massage Room
- Gift Shop
- Laundry Service
- Complimentary bicycles on board
- Wi-Fi available
- Elevator

STATEROOM AMENITIES

- Suites (26,4 m²/284 sq.ft.) on Mozart Deck with comfortable corner sofa, luxurious bathroom and walk-out exterior balcony
- Staterooms (17,5 m²/188 sq.ft.) on Strauss and Mozart Deck with drop-down panoramic windows
- Staterooms (16 m²/172 sq.ft.) on Haydn Deck with smaller panoramic windows (cannot be opened)
- Cabins with connecting doors are available on Haydn Deck on request
- Mini-Bar (all staterooms except C-1 and C-4)
- Walk-in wardrobe
- Choice of bed configuration: double or twin bed
- Flat-screen television
- Individual climate control
- Bathrooms with walk-in shower
- Bathrobes
- Hair dryer
- Direct dial telephone
- In-room safe

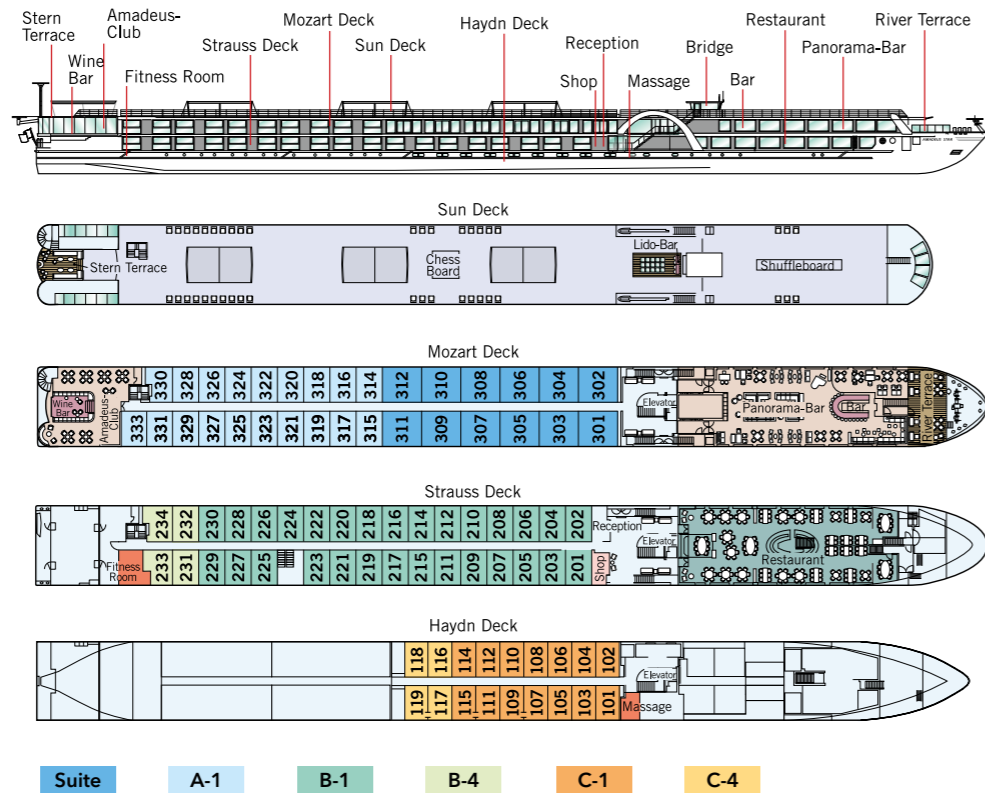

Suite

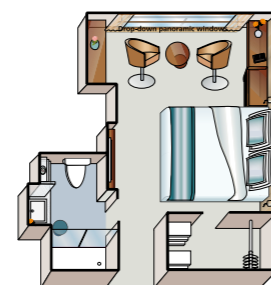

Staterooms, Mozart and Strauss Deck

TECHNICAL DATA

- Built: 2019
- Registry: Germany
- Length: 135 m | 443 feet
- Width: 11,4 m | 37,5 feet
- Height above water: 6 m | 19,8 feet
- Speed: 25 km/h | 15,5 mph
- Decks: 4
- Staterooms/Suites: 70/12
- Max. passengers: 164
- Crew members: approx. 46

ONBOARD FACILITIES

- Panorama-Restaurant
- Panorama-Bar and Lounge
- Amadeus-Club
- Outdoor glass-shielded "River Terrace"
- Sun Deck with Lido-Bar, lounge chairs, shade awnings, giant Chess Board and Shuffleboard
- Indoor Pool
- Fitness Room
- Massage Room
- Gift Shop, Laundry Service
- Complimentary bicycles on board
- Wi-Fi available
- Elevator

STATEROOM AMENITIES

- Suites (26,4 m²/284 sq.ft.) on Mozart Deck with comfortable corner sofa, luxurious bathroom and walk-out exterior balcony
- Staterooms (17,5 m²/188 sq.ft.) on Strauss and Mozart Deck with drop-down panoramic windows
- Staterooms (16 m²/172 sq.ft.) on Haydn Deck with smaller panoramic windows (cannot be opened)
- Cabins with connecting doors are available on Haydn Deck on request
- Mini-Bar (all staterooms except C-1 and C-4)
- Walk-in wardrobe
- Choice of bed configuration: double or twin bed
- Flat-screen television
- Individual climate control
- En-suite bathrooms with shower/WC, Hair dryer
- Bathrobe in Suites
- Direct dial telephone
- In-room safe

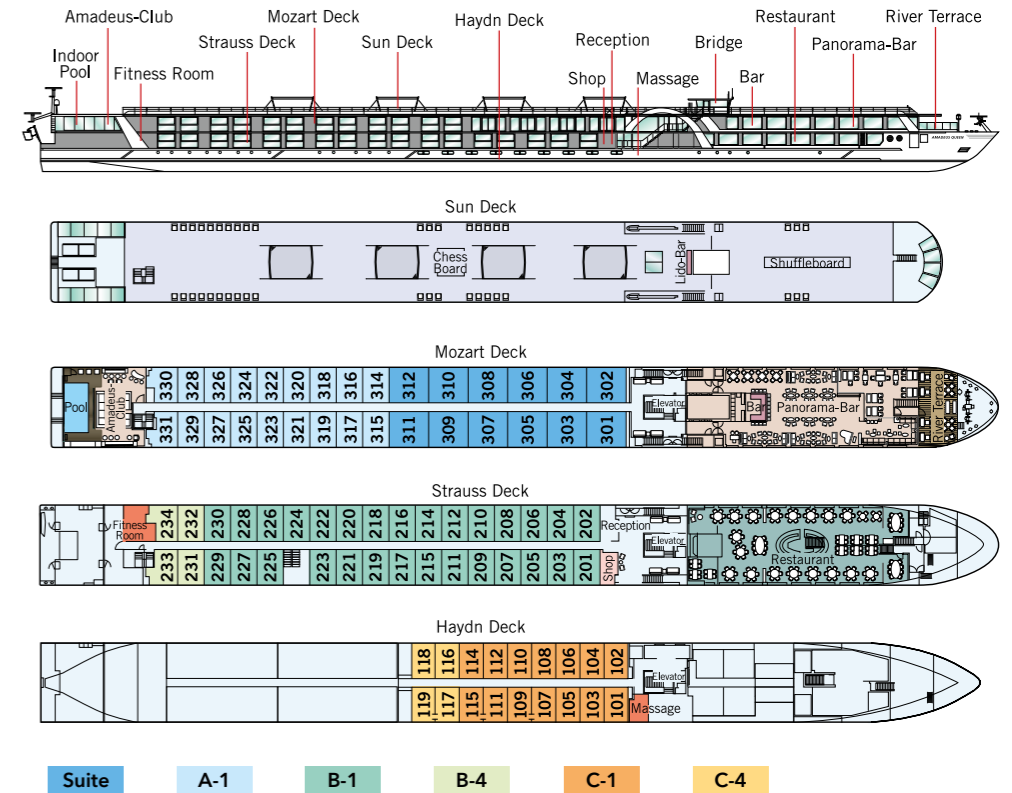

Suite

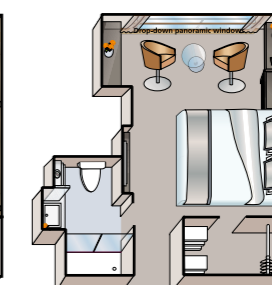

Staterooms, Mozart and Strauss Deck

TECHNICAL DATA

- Built: 2018
- Registry: Germany
- Length: 135 m | 443 feet
- Width: 11,4 m | 37,5 feet
- Draft: 1,45 m | 5 feet
- Height above water: 6 m | 19,8 feet
- Speed: 25 km/h | 15,5 mph
- Decks: 4
- Staterooms/Suites: 69/12
- Max. passengers: 162
- Crew members: approx. 46

AMADEUS PROVENCE



Infinity Pool



Stateroom, Mozart and Strauss Deck



Suite, Mozart Deck

ONBOARD FACILITIES

- Panorama-Restaurant
- Panorama-Bar
- Amadeus-Club
- Outdoor glass-shielded "River Terrace"
- Sun Deck with lounge chairs, shade awnings, giant Chess Board and Shuffleboard
- Pool Deck with swimming pool and Lido-Bar
- Fitness Room
- Massage Room
- Gift Shop, Laundry Service
- Complimentary bicycles on board
- Wi-Fi available
- Elevator

STATEROOM AMENITIES

- Suites (26,4 m²/284 sq.ft.) on Mozart Deck with comfortable corner sofa, luxurious bathroom and walk-out exterior balcony
- Staterooms (17,5 m²/188 sq.ft.) on Strauss and Mozart Deck with drop-down panoramic windows
- Staterooms (16 m²/172 sq.ft.) on Haydn Deck with smaller panoramic windows (cannot be opened)
- Cabins with connecting doors are available on Haydn Deck on request
- Mini-Bar (all staterooms except C-1 and C-4)
- Walk-in wardrobe
- Choice of bed configuration: double or twin bed
- Flat-screen television
- Individual climate control
- En-suite bathrooms with shower/WC, Hair dryer
- Bathrobe in Suites
- Direct dial telephone
- In-room safe

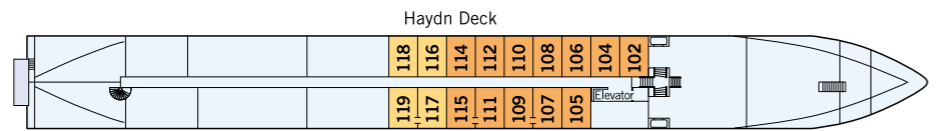
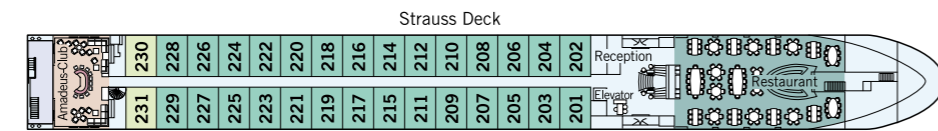
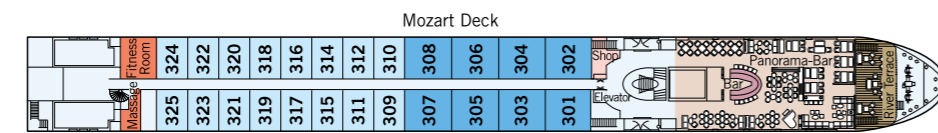
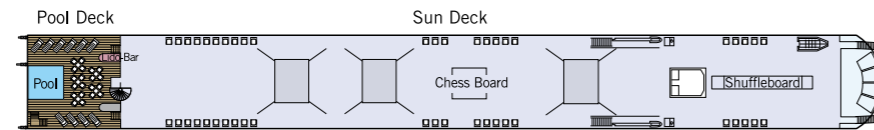
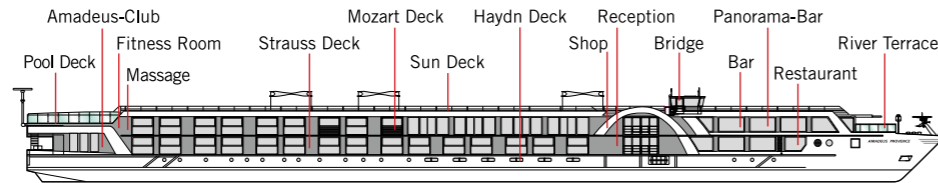

Suite

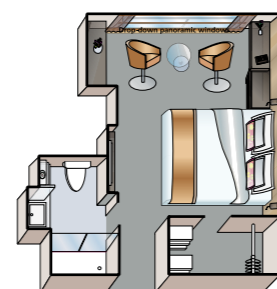

Stateroom, Mozart and Strauss Deck

TECHNICAL DATA

- Built: 2017
- Registry: Germany
- Length: 110 m | 361 feet
- Width: 11 m | 36,5 feet
- Draft: 1,45 m | 5 feet
- Height above water: 6 m | 19,8 feet
- Speed: 25 km/h | 15,5 mph
- Decks: 4
- Staterooms/Suites: 62/8
- Max. passengers: 140
- Crew members: approx. 40

AMADEUS SILVER III



Stateroom, Mozart and Strauss Deck



Panorama-Bar and Lounge



Suite, Mozart Deck

ONBOARD FACILITIES

- Panorama-Restaurant
- Panorama-Bar and Lounge
- Amadeus-Club
- "Café Vienna" with Viennese coffee specialties
- Outdoor glass-shielded "River Terrace"
- Sun Deck with Lido-Bar, lounge chairs, shade awnings, giant Chess Board and Shuffleboard
- Fitness Room
- Massage Room
- Gift Shop, Laundry Service
- Complimentary bicycles on board
- Wi-Fi available
- Elevator

STATEROOM AMENITIES

- Suites (26,4 m²/284 sq.ft.) on Mozart Deck with comfortable corner sofa, luxurious bathroom and walk-out exterior balcony
- Staterooms (17,5 m²/188 sq.ft.) on Strauss and Mozart Deck with drop-down panoramic windows
- Staterooms (16 m²/172 sq.ft.) on Haydn Deck with smaller panoramic windows (cannot be opened)
- Cabins with connecting doors are available on Haydn Deck on request
- Mini-Bar (all staterooms except categories C-1 and C-4)
- Walk-in wardrobe
- Choice of bed configuration: double or twin bed
- Flat-screen television
- Individual climate control
- En-suite bathrooms with shower/WC, Hair dryer
- Bathrobe in Suites
- Direct dial telephone
- In-room safe

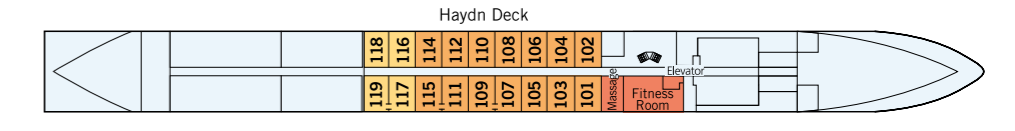
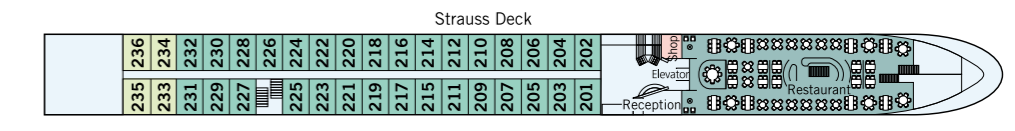
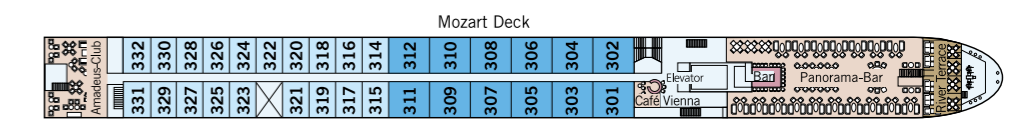
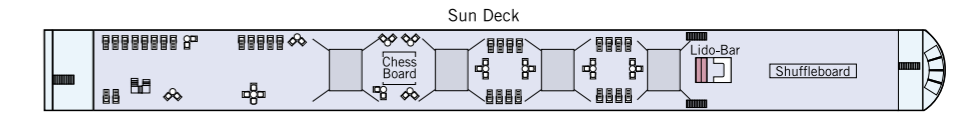
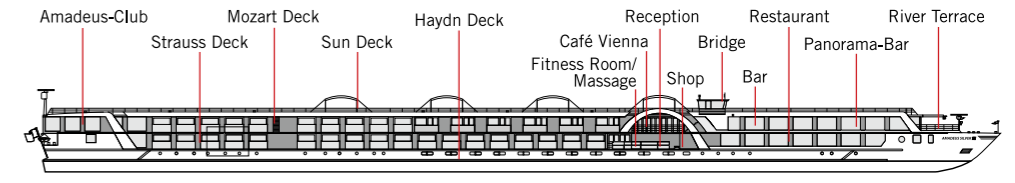

Suite

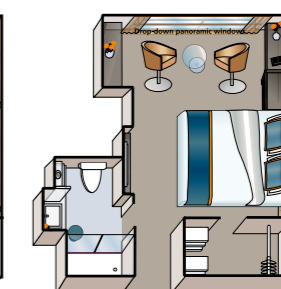

Stateroom, Mozart and Strauss Deck

TECHNICAL DATA

- Built: 2016
- Registry: Germany
- Length: 135 m | 443 feet
- Width: 11,4 m | 37,5 feet
- Draft: 1,45 m | 5 feet
- Height above water: 6 m | 19,8 feet
- Speed: 25 km/h | 15,5 mph
- Decks: 4
- Staterooms/Suites: 72/12
- Max. passengers: 168
- Crew members: approx. 46

AMADEUS BRILLIANT



Suite, Mozart Deck



Amadeus-Club



Stateroom, Mozart and Strauss Deck

ONBOARD FACILITIES

- Panorama-Restaurant
- Panorama-Bar und Lounge
- Amadeus-Club with Internet station
- Sun Deck with Lido-Bar, lounge chairs, shade awnings, giant Chess Board and Shuffleboard
- Fitness Room
- Massage Room
- Gift Shop, Laundry Service
- Complimentary bicycles on board
- Wi-Fi available
- Elevator

STATEROOM AMENITIES

- Suites (22 m²/237 sq.ft.) on Mozart Deck with floor-to-ceiling sliding-glass doors with French Balcony and Mini-Bar
- Staterooms (15 m²/161,5 sq.ft.) on Strauss and Mozart Deck with floor-to-ceiling sliding-glass doors with French Balcony
- Staterooms (15 m²/161,5 sq.ft.) on Haydn Deck with smaller panoramic windows (cannot be opened)
- Two single cabins (10 m²/107,5 sq.ft.) on Haydn Deck with smaller panoramic windows
- Ample closet space
- Choice of bed configuration: double or twin bed
- Flat-screen television
- Individual climate control
- En-suite bathrooms with shower/WC, Hair dryer
- Bathrobe in Suites
- Direct dial telephone
- In-room safe

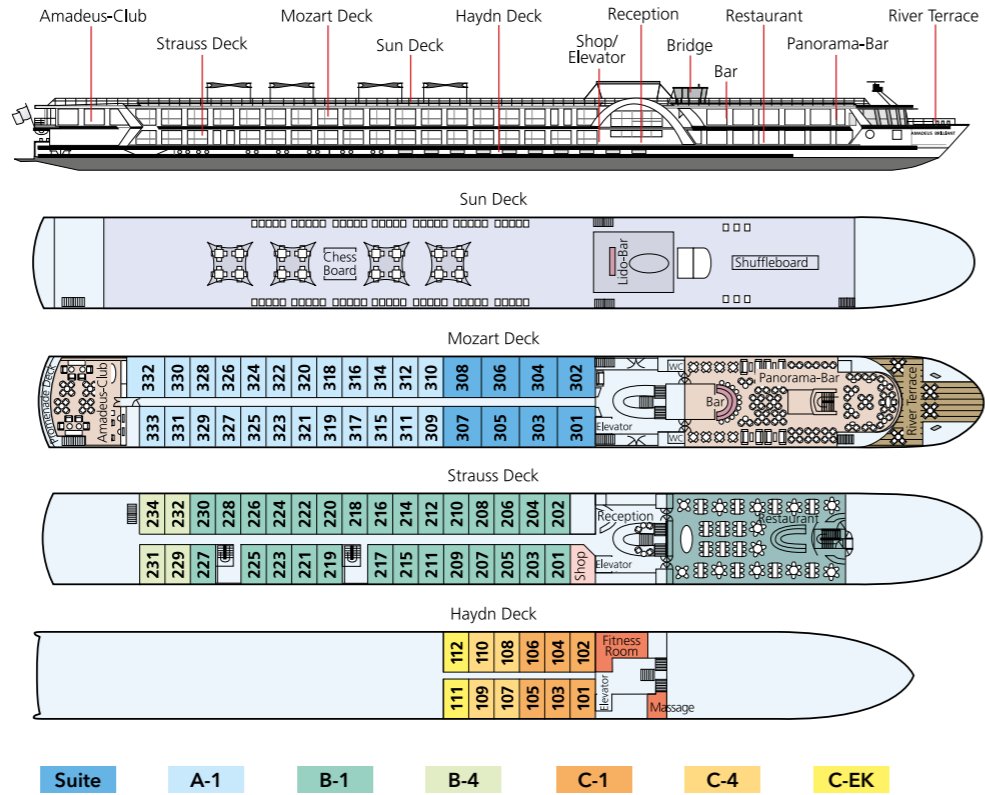

Suite

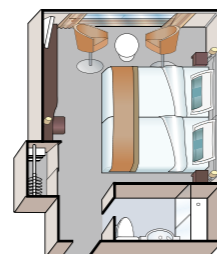

Stateroom, Mozart and Strauss Deck

TECHNICAL DATA

- Built: 2011
- Complete renovation: 2020
- Registry: Germany
- Length: 110 m | 361 feet
- Width: 11,4 m | 37,5 feet
- Draft: 1,30 m | 4,4 feet
- Height above water: 5,85 m | 19,2 feet
- Speed: 25 km/h | 15,5 mph
- Decks: 4
- Staterooms/Suites: 68/8
- Max. passengers: 150
- Crew members: approx. 40

AMADEUS DIAMOND



Stateroom, Mozart and Strauss Deck



Amadeus-Club



Suite, Mozart Deck

ONBOARD FACILITIES

- Panorama-Restaurant
- Panorama-Bar und Lounge
- Amadeus-Club with Internet station
- Sun Deck with Lido-Bar, lounge chairs, shade awnings, giant Chess Board, Golf Putting Green and Shuffleboard
- Fitness Room, Massage Room
- Gift Shop, Laundry Service
- Complimentary bicycles on board
- Wi-Fi available
- Elevator

STATEROOM AMENITIES

- Suites (22 m²/237 sq.ft.) on Mozart Deck with floor-to-ceiling sliding-glass doors with French Balcony and Mini-Bar
- Staterooms (15 m²/161,5 sq.ft.) on Strauss and Mozart Deck with floor-to-ceiling sliding-glass doors with French Balcony
- Staterooms (15 m²/161,5 sq.ft.) on Haydn Deck with smaller panoramic windows (cannot be opened)
- Two single cabins (10 m²/107,5 sq.ft.) on Haydn Deck with smaller panoramic windows
- Ample closet space
- Choice of bed configuration: double or twin bed
- Flat-screen television
- Individual climate control
- En-suite bathrooms with shower/WC in staterooms, bathtub/WC in Suites
- Bathrobe in Suites
- Hair dryer
- Direct dial telephone
- In-room safe

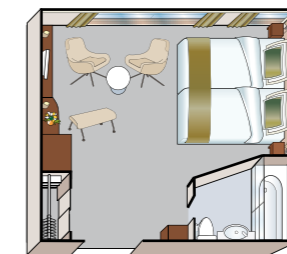
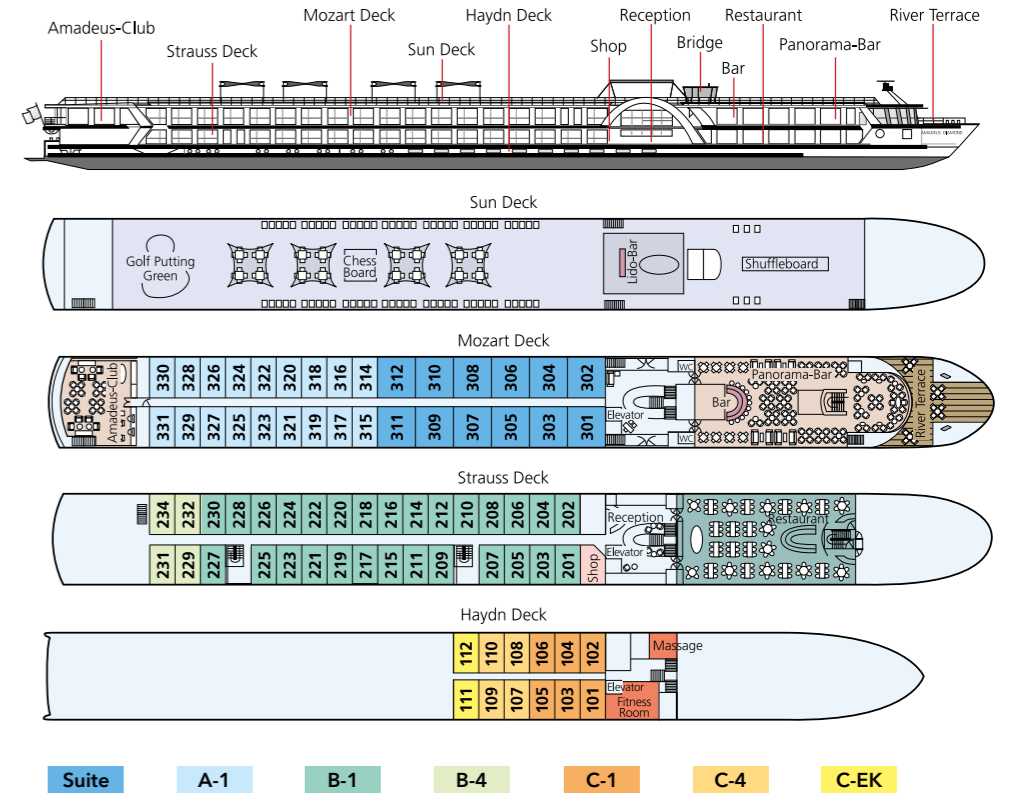

Suite

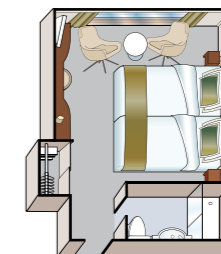

Stateroom, Mozart and Strauss Deck

TECHNICAL DATA

- Built: 2009
- Complete renovation: 2019
- Length: 110 m | 361 feet
- Width: 11,4 m | 37,5 feet
- Draft: 1,30 m | 4,4 feet
- Height above water: 5,85 m | 19,2 feet
- Speed: 25 km/h | 15,5 mph
- Decks: 4
- Staterooms/Suites: 62/12
- Max. passengers: 146
- Crew members: approx. 40



ARRIVE AND DISCOVER

Shore Excursions 2024

Koblenz: the famous "Deutsche Eck" (German corner), the confluence of the Rhine and Moselle rivers

EXCURSIONS: INSPIRATIONAL DISCOVERIES ON LAND

With our carefully crafted itineraries and land excursions, you can immerse yourself in the world of Europe's major cities, small villages, and landscapes and get to know the art, culture, and people of these countries. Our 'à la carte' excursion packages are tailored to allow you to customize your experience.

You'll be provided a wireless AMADEUS listening device on all our excursions. The receiver can be worn comfortably around the neck or carried in a bag. The comfortable headphones allow you to hear your experienced tour guide's explanations with the best acoustic quality. Enjoy complete freedom of movement without missing any of the exciting commentaries.

INDEX OF COUNTRIES

Austria.....	133 – 134	Germany	139 – 143
Belgium.....	134	Hungary	143 – 144
Bulgaria.....	134 – 135	Luxembourg.....	144
Croatia.....	135	The Netherlands ..	144 – 145
France.....	135 – 139	Romania.....	146
Rhine	135	Serbia	146 – 147
Rhône Saône.....	136 – 137	Slovakia.....	147
Seine.....	137 – 139	Switzerland.....	147

IMPORTANT INFORMATION

- All excursions can be booked in advance or aboard. (For organizational reasons, some excursions can only be booked aboard.)
- Minimum participation for excursions by bus: 20 people; Minimum participation for walking excursions: 12 people
- The schedule of individual excursions can vary; this is partly due to the volume of traffic in the cities and the opening hours of facilities.
- We recommend sturdy shoes, comfortable clothes and an umbrella or waterproof jacket for excursions.
- When exploring on your own, please remember to return to the vessel in time for its departure. If you arrive after the scheduled departure time you will need to travel to the next port of call at your own expense. The scheduled all aboard time will be listed in the daily program.
- Itineraries and prices are subject to change.

EXCURSION INFORMATION

Some excursions involve a fair amount of walking, sometimes over uneven surfaces. The following coding system has been used to assist with identifying which excursions are appropriate for you. Please ask your cruise director for additional information as required.

- **LEVEL 1:** Minimum walking; excursion by bus with short photo stops.
- **LEVEL 2:** The excursion by bus is followed by a moderate walking tour. You may need to climb some stairs.
- **LEVEL 3:** The excursion by bus is followed by a longer walk. You may need to climb several stairs.
- **LEVEL 4:** Moderate walking tour. You may need to climb some stairs.
- **LEVEL 5:** Considerable walk with longer distances. This may include uneven surfaces and some stairs.

AUSTRIA

VIENNA – IMPERIAL DISCOVERY TOUR

While it may take days or weeks to fully discover Vienna, this tour will introduce you to the most iconic sights the Austrian capital offers. Begin with a panoramic drive along the famous Ringstrasse, passing several magnificent architectural sites like the stunning Opera House, the parliament, the Court Theatre, and the City Hall, built of quarry stones and ashlars.

Continue with a guided stroll through the city center. Begin at the well-known Hofburg Imperial Palace, walk along the Kohl market, and finish at Vienna's iconic St. Stephen's cathedral. Before returning to the ship, enjoy free time to explore the pedestrian area.

Duration: approx. 3,5 hrs Walking grade: ●● € 46,00

VISIT TO SCHÖNBRUNN PALACE

Travel by coach to one of the most beautiful sights of Vienna. Being one of the most revered cultural heritage sites in Austria, Schönbrunn Palace and its gardens were declared a UNESCO World Cultural Heritage site. The reign of Maria Theresia signified the most splendid era for Schönbrunn. The castle and park were the center of court and political life. Under the personal guidance of the Empress, it was remodeled and expanded to become a royal residence; a complex with a total of 1,441 rooms and halls was created. Visit many of the ceremonial rooms and walk around the well-manicured gardens.

Duration: approx. 3,5 hrs Walking grade: ●● € 67,00

VISIT TO SCHÖNBRUNN PALACE WITH CHRISTMAS MARKET

[See description for "Visit to Schönbrunn Palace"] The festive courtyard in front of Schönbrunn Palace presents itself in a blaze of lights and many lovingly decorated market stalls and a vast array of culinary delights. Christmas melodies, the scent of roasted almonds and the magnificent historical backdrop will put you in the right Advent mood.

Duration: approx. 3,5 hrs Walking grade: ●● € 67,00

"SOUND OF VIENNA" CLASSICAL CONCERT

In the very place where Johann Strauss himself once directed his orchestra from his position as first violin, the true essence of Vienna's classical music can once again be heard daily. The "Salonorchester Alt Wien", one of the best-known interpreters of classical Viennese music, presents an evening full of Viennese charm with the lilting sound of waltzes, polkas, arias, and duets, as well as operetta and piano concerto melodies. Accompanied by excellent opera vocalists and our enchanting ballet soloists, Vienna's classical music is a living firework display for all the senses.

Duration: approx. 3 hrs Walking grade: ● Cat. B 73,00 (Bookable only on board: Cat. A € 83,00)

LINZ WALKING TOUR WITH LINZER TORTE TASTING

Connecting several trade routes, the upper Austrian state capital was a provincial and local government city of the Holy Roman Empire and an important trade center. As the city where the Habsburg Emperor Friedrich III spent his last years, it was, for a short period of time, the most important city in the Empire. After the death of the Emperor in 1493, Linz lost its status to Vienna and Prague. Take a stroll down the main street leading to the main square. In addition to the medieval town square in the historic old town and the Mozarthaus, see baroque bourgeois family houses, the old cathedral with the Bruckner organ or the new cathedral. Visits depend on Cathedral and Mass openings/times. Visible from afar is the pilgrimage basilica on the mountain Poestling, the landmark of the town. Modern counterparts are the Lentos art museum and the Ars Electronica center, with its striking glass facade.

Time-permitting, conclude the tour with a slice of Linzer Torte – the sweet ambassador of Linz and the oldest known cake recipe.

Duration: approx. 2 hrs Walking grade: ●●●● € 27,00

LINZ WALKING TOUR WITH LINZER TORTE TASTING

(from Linz/to Aschach)

[See description "Linz walking tour with Linzer Torte tasting"]

Afterwards, your coach takes you to rejoin the ship in Aschach.

Duration: approx. 2,5 hrs Walking grade: ●●●● € 42,00

TRIP TO THE PÖSTLINGBERG

Walk along the banks of the Danube to Linz's main square, where the Pöstlingberg narrow gauge train or 'mountain tramway' awaits. The railway that goes up Linz's highest hill was built in 1898 and reconstructed in 2009, impressing as one of the steepest adhesion railways in the world. After the ride to the 1,768 feet (539 m) summit, it is only a short walk to the church Seven Sorrows of Virgin Mary, built between 1742 and 1747. This landmark of Linz is also a local pilgrimage destination. In the 19th century, Archduke Maximilian Joseph of Austria built a fortification around Linz, building towers on Pöstlingberg Hill to mark the highest point. One of the towers has a popular terrace (recommended weather permitting) providing sweeping views of Linz and the surrounding countryside.

Duration: approx. 2,5 hrs Walking grade: ●●●●● € 35,00

FULL-DAY SALZBURG WITH LUNCH

A two-hour coach ride will bring you to Salzburg – the city of music. On arrival, marvel from afar at the fortress 'Hohensalzburg' high up on the hill. The old town with its world-famous Baroque architecture is one of the best-preserved city centers north of the Alps. It was adopted by UNESCO in 1997 and is included on its list of World Cultural Heritage Sites.

During the guided tour through the old town you will see the birth house of Mozart (exterior only), as well as other well-known attractions, such as the 'Getreidegasse' and the early baroque cathedral dominating the main square, where the Salzburg festival takes place.

After a complimentary lunch, head to the picturesque village of Mondsee, best known as a film location for the famous movie "The Sound of Music". Enjoy the dramatic scenery as you return to the ship.

Duration: approx. 9,5 hrs Walking grade: ●●● € 125,00

FULL-DAY SALZBURG INCL. SALZKAMMERGUT, LUNCH AND CHRISTMAS MARKET

A two-hour coach ride will bring you to Salzburg – the city of music. The old town with its world-famous Baroque architecture is one of the best-preserved city centers north of the Alps. It was adopted by UNESCO in 1997 and is included on its list of World Cultural Heritage Sites. Salzburg is also the birthplace of Wolfgang Amadeus Mozart. During the guided tour through the old town you will see the birth house of the musician (exterior only), as well as other well-known attractions, such as the Getreidegasse. This long, narrow shopping street runs parallel to the river in the center of town. The street is famous for its old-style signage outside each store, indicating the profession found within. Continue to Mirabell Palace, a beautiful castle with gardens, built by an archbishop for his beloved courtesan. The Garden of Dwarfs and the Garden of Roses are especially beautiful. After enjoying an included lunch, you will have the opportunity to stroll through the Christmas market.

Duration: approx. 9,5 hrs Walking grade: ●●●● € 125,00

DÜRNSTEIN WALKING TOUR WITH WINE TASTING

Located in the heart of the magnificent Wachau Valley, on the banks of the mighty river Danube, this well-known wine village offers the unique combination of breathtaking scenery, traditional architecture, and places of historic interest. Walk through the romantic old town of Dürnstein, past the town walls and the Pranger Square with its lovely view of the castle ruins. Walk along the Convent of Klarissen, past the baroque monastery and the pedestrian area, to the charming Hotel Schloss Dürnstein.

Enjoy a complimentary glass of wine in this peaceful village.

Duration: approx. 2 hrs Walking grade: ●●●● € 33,00

DÜRNSTEIN WALKING TOUR & ABBEY

One of the most beautifully situated towns in the Wachau River Valley is nestled between many terraced vineyards. Your walking tour offers views of breathtaking scenery, traditional architecture and historic sights. Explore the picturesque old town, the city walls, the Prager Platz with vistas of the castle ruins high above, where King Richard I was held captive by Leopold V – Duke of Austria after a dispute during the Third Crusade. Walk along the Clarissan Monastery to the Canons' Abbey, which was founded in 1410 and rebuilt in the Baroque style in 1710. Enter through the monastery portal and discover the courtyard as you explore the abbey. A highlight is a breathtaking view from the Danube terrace underneath the iconic blue tower visible from the river. *Duration: approx. 2 hrs* *Walking grade: ●●●●* € 33,00

MELK ABBEY – A BAROQUE JEWEL

This Austrian Benedictine abbey is one of the world's most famous monastic sites. It was built between 1702 and 1736 and is the biggest monastery complex of the Austrian baroque period. The abbey's church, with frescos by Johann Michael Rottmayr, and the famed library with countless medieval manuscripts and frescos by Paul Troger are particularly noteworthy. A guided tour takes you through the abbot's chambers, along the emperor's walk, through the marble hall, the balconies and the library. It is no surprise that the Italian writer Umberto Eco drew inspiration from this site for his novel "The Name of the Rose", in which a monastic library plays a key role. *Duration: approx. 2 hrs* *Walking grade: ●●●* € 61,00

VISIT TO MELK ABBEY AND WALKING TOUR IN MELK

[See description "Melk Abbey – A Baroque Jewel"]
Complete this excursion with a walking tour of the picturesque city of Melk with its rich history. *Duration: approx. 4 hrs* *Walking grade: ●●●* € 70,00

WINZER KREMS – VINEYARD AND WINERY

The heart of the Austrian wine region, the Wachau Valley is a rich wine growing area with 1,350 hectares of vines planted on the hills and mountainsides. The predominant grape is Grüner Veltliner with some Riesling and a smaller amount of other whites. Visit a Krems wine estate and learn more about its origin, history, its culture and unique wine. The Krems winery unites 980 vineyards from Krems and the surrounding wine-growing villages. Embark on a journey through the variations of the noble grape and peak behind the scenes of the wine-growing industry. Taste different wines of the region before returning to the ship. (closed on Sundays and public holidays from November to May) *Duration: approx. 3 hrs* *Walking grade: ●●●●●* € 53,00

BELGIUM

ANTWERP AND THE CATHEDRAL OF OUR LADY

Discover Antwerp one of Europe's largest ports. Walk through the attractive old center of the city and visit the Lieve-Vrouwe Cathedral (Cathedral of Our Lady), the largest Gothic church in Belgium. It contains valuable treasures, such as works by Rubens, wall paintings dating back to the 15th century, and many more. However, the church is more than just a museum; it is still an active place of worship. After your visit to the cathedral, enjoy some free time to explore the lively shopping scene, which sends visitors into genuine frenzies. *Duration: approx. 3,5 hrs* *Walking grade: ●●* € 55,00

BRUGES – VENICE OF THE NORTH

Travel overland by coach to Bruges. Due to the canal system, the city is – like Amsterdam – also known as the "Venice of the North" and is one of the most beautiful cities in Europe. The historic marketplace, the center of old Bruges, is cradled by the river Reie and was recognized as Cultural World Heritage Site by UNESCO. Walking along the maze of winding, cobbled alleys and romantic canals, you will be transported to medieval times. Besides various other sights, the market, the 'Burg' (the site of the former Bruges castle) and the Basilica of the Holy Blood are especially worth seeing. *Duration: approx. 5 hrs* *Walking grade: ●●●* € 52,00

BRUSSELS WITH ATOMIUM AND CINQUANTEAIRE PARK

After a comfortable coach ride, you will reach Brussels, the capital of Belgium. Your tour starts in the verdant Laken area, which boasts landmarks such as the Heysel stadium, Notre Dame of Laken, the famous Atomium, and the royal residence. The tour continues through the city's eastern part, including the 30-hectare Cinquanteaire Park esplanade with its U-shaped building complex and the city center with the Royal Palace, the city park, and the Palace of Justice. To conclude the tour, walk through Europe's oldest shopping mall before returning to the ship. *Duration: approx. 4,5 hrs* *Walking grade: ●●* € 52,00

GHENT WITH GRAVENSTEEN MEDIEVAL FORTRESS

Discover one of the most attractive cities in Belgium with a rich heritage of medieval buildings. Stroll through the picturesque center, and pass by the UNESCO World Heritage Ghent Belfry, where 54 bells ring out. Continue with a visit to St. Bavo Cathedral and admire one of the most important works of art of the Middle Ages – the Ghent Altarpiece by Hubert and Jan van Eyck. Afterward, visit the Castle of the Counts (Gravensteen Fortress), built in the 12th century by the Count of Flanders after his return from the Crusades. It is the only preserved medieval moated castle with an almost entirely intact defense system in Flanders. Enjoy free time to explore the city on your own before returning to the ship. *Duration: approx. 3,5 hrs* *Walking grade: ●●●●●* € 59,00

BULGARIA

ROUSSE WITH BASARBOVO MONASTERY

From the port of Rousse, head towards the rock monastery of Basarbovo, an active cave monastery built in the 16th century, about 35 meters above the river. Discover the church of St. Dimitar and its history, spectacular view, and frescoes. After the visit, return to Rousse, a 2000-year-old Danube city full of culture and traditions. The belle époque architecture testifies to the town's economic prosperity at the beginning of the 20th century. Neatly trimmed squares and buildings illustrate the influence of the architectural styles of Vienna, Budapest, and Bucharest, with elements of Baroque, Renaissance, Secession, and Empire. The highlight of this architectural ensemble is the State Opera House and the pyramidal Monument of Liberty, depicting scenes from the

battles for national liberation. Explore the city center on foot and enjoy a glass of Bulgarian wine and some "banitzza" (cheese pastry) in a typical restaurant before rejoining the ship in Svishtov. *Duration: approx. 5 hrs* *Walking grade: ●●●●●* € 66,00

VIDIN WALKING TOUR

Located in North-Western Bulgaria, Vidin is one of the oldest cities in Bulgaria and was once an important Roman trading town. Explore the central main square, the Ploshtad Bdintsi (Bdintsi Square), and the main gate, Stambol Kapia, which date back to Ottoman times. Stroll through the Danube Park, which stretches along the entire riverbank to the Baba Vida Fortress. Austrian architects designed this secluded avenue and is home to numerous restaurants, cafes, and ice cream shops, as well as the Nikola Petrov Museum with Bulgarian art and other artifacts of Vidin. *Duration: approx. 1,5 hrs* *Walking grade: ●●●●●* € 23,00

EXCURSION TO THE BABA VIDA FORTRESS WITH CONCERT

Your bus will take you to the landmark of Vidin, Baba Vida Fortress, towering high above the city, where a short classical concert will enchant you. The gate towers and walls on the curving bank of the Danube are the most important sight of Vidin. The fortress was the last Bulgarian bulwark to be taken by the Ottomans in 1396 and is today one of the best-preserved fortifications in Bulgaria. Its origins date back to the Roman fortification of the former settlement of Bononia. *Duration: approx. 3,5 hrs* *Walking grade: ●●●●* € 54,00

VELIKO TARNOVO – CULTURAL CAPITAL OF THE BALKANS

This excursion heads towards Veliko Tarnovo in a comfortable coach. Picturesquely located on the steep banks of the river Yantra at the foot of the Balkan Mountains, the houses of this medieval town were built on narrow terraces along the steep, rocky slopes. Pass by the Tsarevets Fortress, where 22 tsars made history in the 2nd Bulgarian empire. Take photos of the fortress during a stop. Visit the 13th-century church St. Peter and Paul, one of the few kept intact since the beginning of the XIII century and used for worship until the earthquake in 1913. At the end of the tour, enjoy seeing local arts and crafts in a nearby shopping street. *Duration: approx. 5 hrs* *Walking grade: ●●●* € 68,00

VELIKO TARNOVO AND ARBANASSI WITH LUNCH

A comfortable bus drive through the Danube plains takes you to the museum village of Arbanassi, with its unique houses that look like small fortresses. Arbanassi is famous for its painted churches and artist market. Use the coffee break to enjoy the splendid view from the terrace over one of Bulgaria's most picturesque and quaint places at the foot of the Balkan Mountains – the city of Veliko Tarnovo. Look inside an authentic Middle Ages house, the "Konstantsalievka," to see the fantastic amenities wealthy families in Arbanassi had two centuries ago. Enter the richly decorated Nativity Church to admire some of the earliest frescoes in the region. Discover Bulgarian cuisine during lunch in a local restaurant. Continue to Veliko Tarnovo, the medieval capital of Bulgaria, with more than 5,000 years of history. Take pictures during the photo stop at the Tsarevets Fortress and learn about the history of Bulgarian kings. Search for a unique souvenir as you stroll along the many handicraft shops. *Duration: approx. 6 hrs* *Walking grade: ●●* € 97,00

CROATIA

VUKOVAR EVENING WALKING TOUR

At the intersection of roads, Vukovar has always been a place of contact between different cultures but also the scene of wars. Walk through the city center and marvel at the historic buildings, including the new water tower, the church of St. Philip and Jacob, the white marble stone cross memorial, and the old water tower. Pass by the historical Hotel Grand, the Town Hall, and the birth house of the first

Croatian Nobel prize winner, Leopold Ružicka. At the end of the tour, you will have some free time to explore the city before returning to the ship. *Duration: approx. 2 hrs* *Walking grade: ●●●●●* € 33,00

VUKOVAR, OSIJEK AND KOPACKI RIT

Your experience begins in Vukovar, named after the small river Vuka and home to the largest cargo port in former Yugoslavia. Drive through its streets, once rimmed with elegant baroque mansions. View damaged factory facilities in use before the war in 1991. Learn about the everyday life of Croatians on your way to Kopački Rit, the largest nature park in Eastern Croatia. Join a boat tour through this protected wetland and marshy landscape. Continue to the village of Kopačevo and visit the Rural House for a presentation of traditional fishing tools spiced up with humorous fishermen stories. Taste typical Croatian products: fruit brandy, local wine, smoked pork sausage, ajvar, and homemade cakes. Continue to Osijek to stroll through the old town with its baroque military fortress built in the 18th century, now the heart of Osijek's cultural life. The Church of the Raising of the Holy Cross impresses inside the fort with a richly decorated interior. Take a walking tour to the remaining part of the walls with the so-called "Watergate", the main square containing a giant baroque statue in Croatia, museums, galleries, schools, and pubs. Once returned to your coach, continue with a scenic drive back to Vukovar, passing past Croatia's first brewery. *Duration: approx. 4,5 hrs* *Walking grade: ●●* € 71,00

FRANCE: Rhine

THE ROMANTIC ALSACE AND ITS WINES

Drive through picturesque landscapes, romantic wine villages, and parts of the famous wine route. Visit a local winery for a tasting of the local wines. Your excursion continues to the medieval village of Obernai. During a stroll through this idyllic Alsatian town steeped in rich history, you will learn the charm of its traditional, half-timbered houses, Belfry, and town center. *Duration: approx. 4 hrs* *Walking grade: ●●* € 78,00

WINTRY ALSACE AND OBERNAI

On this excursion, we drive through Alsace's romantic wintry landscapes to discover the Gertwiller village, famous for its Lebkuchen (Christmas gingerbreads). After an included glass of Mulled wine, the tour continues to the magical little town of Obernai, where we stroll through the old quarter – delightfully decorated for Christmas. Admire the Christmas crib with its life-size figures of people and animals set up in the marketplace each year for centuries. *Duration: approx. 4 hrs* *Walking grade: ●●●* € 78,00

STRASBOURG WITH CANAL BOAT TOUR / STRASBOURG WITH VISIT TO THE CHRISTMAS MARKET

Enjoy a discovery tour through the remarkable city of Strasbourg. After a short coach trip through the city, the tour continues with a walk through the lovely, historic old part of the town and includes a visit to the famous cathedral Straßburger Münster (not possible on Sundays and public holidays, sometimes with security checks). Discover the renowned quarter "Petite France" during a boat cruise on the river. This former mill and tanner district still maintains its medieval charm. Some of its beautiful, half-timbered houses are up to 500 years old. The Ponts Couverts crossing the four river channels of the River Ill, Palais de Rohan, and the Council of Europe are just some of the wonders Strasbourg has in store for you. **Please note:** From Nov. 25th to Dec. 24th, the boat cruise will be replaced by a visit to the Christmas Market. *Duration: approx. 4 hrs* *Walking grade: ●●* € 76,00



Bruges – UNESCO World Heritage



© ichr/Shutterstock.com

and hundreds of meters of cellars, which are notable for containing the personal reserve of the Hospices. The four buildings open to the public are situated around the Court of Honor and represent the Hôtel-Dieu of former times. The great Salle des Pauvres ("hall of the poor") is decorated with multi-colored beams which are unique worldwide. Serenity reigns here, which will leave no one unmoved. The rooms overflow with treasures: statues, furniture, pottery, paintings, tapestries, and more. The kitchen has been restored to look exactly as it did in the 19th century. The polyptych of "The Last Judgement," a masterpiece by the Flemish painter Rogier Van Der Weyden, is mainly well presented. Later, enjoy a wine-tasting experience at one of Beaune's famous cellars.

Duration: approx. 4 hrs *Walking grade: ●●* € 87,00

MEDIEVAL BRANCION AND CORMATIN

We leave Chalon-sur-Saône and drive to Brancion for a short photo stop before continuing to the Castle of Cormatin. Behind its understated exterior lies inestimable splendor. The castle is undoubtedly one of the most sumptuous castles in Burgundy, and, in addition, it boasts a Renaissance garden. The sculpted yews break up the symmetry as you enter this moated château. The rich, colorful interior reflects the French and, more particularly, the Parisian fashion during the reign of Louis XIII. Built between 1605 and 1629 by the du Blé family, it chronicles the history of the arts at this time in France. The formal Renaissance garden has the "fountain of life" at its center. Beyond this is a maze with a charming wrought-iron aviary. From the top of this, you can get an overview of the park.

Duration: approx. 4 hrs *Walking grade: ●●* € 76,00

LYON – GASTRONOMIC CAPITAL OF FRANCE

Lyon not only marks the meeting of the Saône and Rhône Rivers, but it is also the gastronomic capital of France. Its rich, ancient history includes Roman ruins and early Christian sites. The city tour begins with a coach trip to the Notre Dame de Fourvière Basilica. The well-known pilgrimage church stands on a hill, offering an unforgettable city view. After a brief stop, drive along the banks of the Saône, with views of various sights, including the Cathedral of St. John and the Palace of Justice. Afterward, take a gentle stroll through Lyon's Old Town, a UNESCO World Heritage Site, with the famous Roman theater and buildings reflecting the influence of the Italian Renaissance.

Duration: approx. 3 hrs *Walking grade: ●●* € 50,00

LES HALLES BY PAUL BOCUSE WITH TASTING

Lyon is known as the French culinary capital thanks to its many local specialties. In 1859 the first covered market in Lyon, 'Les Halles de Lyon,' was created. Throughout the centuries, the marketplace in Lyon has evolved, been rebuilt to today's standards, and gained a reputation for its high-quality gourmet goods. Michelin-starred Chef Paul Bocuse enjoyed shopping for his restaurants in this marketplace and in 2006, lent his name to Les Halles de Lyon, giving the final stamp of approval to the gastronomic excellence of the goods available. Explore the best producers of Lyon in the three-level market made up of 56 traders – cheese makers, bakers, pastry chefs, delicatessens, and wine merchants, to name a few.

Follow your guides through this maze of merchants and taste the emblematic products of the world capital of gastronomy: wine, cheese, cooked mixed meats, and pastries.

Duration: approx. 2 hrs *Walking grade: ●●* € 60,00

AVIGNON WALKING TOUR WITH POPE PALACE

Today's excursion is a guided walk through Avignon, also known as the "City of Popes", due to the city's role in the Avignon conspiracy of the 14th century when a pope abandoned Rome and fled to Avignon. Its lavish Palais des Papes (Palace of the Popes) is a fortress, place of worship, and palace all in one and is one of the world's most fascinating examples of Gothic architecture. It was the center of the Christian world during the 14th century. Listen to stories of how seven popes resided here between 1309 and 1377. A must-see is the Pont d'Avig-

non, a former 12th-century bridge that once spanned the Rhône and is immortalized in a folk song about dancing on the bridge.

Duration: approx. 2 hrs *Walking grade: ●●●●* € 50,00

ROMAN AQUEDUCT PONT DU GARD AND UZÈS

The Pont du Gard is the most remarkable surviving stretch of a fifty-kilometer-long (thirty-one miles) aqueduct, built by the Romans in the middle of the first century to supply fresh water to Nîmes. With just a seventeen-meter difference in altitude between the beginning and end, the aqueduct was quite an achievement for its time. Some miles further on, near the start of the trench, visit the city of Uzès. This lovely old town perches on a hill above the River Alzon. Half a dozen medieval towers rise above its tiled roofs. The most fetching is the windowed, Pisa-like Tour Fenestrelle, tacked onto the cathedral. The narrow lanes are lined with Renaissance and Neoclassical houses, once residences of the 17th and 18th-century bourgeoisie, who had grown rich on textiles.

Duration: approx. 4,5 hrs *Walking grade: ●●* € 61,00

ARLES WALKING TOUR WITH ARENA

Arles is a city steeped in history. Arles was home to archbishops for centuries and became part of the Kingdom of the Franks and, later on, the capital of the Kingdom of Burgundy. During our two-hour city walk, view many ancient or Roman sights and monuments and see why UNESCO declared Arles a World Heritage Site. A visit to the Roman arena is a must while in Arles. If time allows, take a break in the café that served as the model for Vincent Van Gogh's "Café Terrace at Night." While strolling through the city, you might even meet pilgrims walking the Way of St. James, which begins in Arles!

Duration: approx. 2 hrs *Walking grade: ●●●●* € 36,00

CAMARGUE NATURE RESERVE

The Camargue is like a little country in its own right. Once a few minutes south of Arles, you enter the area's unique atmosphere, with its long, level roads crisscrossing the marshes and farmlands. Part of the Camargue was listed as a nature reserve as early as 1927 to protect the exceptional fauna and flora. In 1970, the whole Island of Camargue (the delta of the Rhône River) was listed as the Regional Nature Park of Camargue. It is home to an astonishing range of wild-life, including the famous Camargue bulls and horses that live in semi-freedom and many hundreds of species of birds. You will also visit Saintes-Maries-de-la-Mer on the Mediterranean Sea, where the Rhône joins the ocean. This village is steeped in history and boasts stunning beaches that meet the Mediterranean Sea's blue waters.

Duration: approx. 4,5 hrs *Walking grade: ●●* € 59,00

VALLEY OF THE ARDÈCHE GORGE

Often referred to as the Grand Canyon of Europe, the Ardèche Gorge has spectacular limestone cliffs towering up to 1,000 ft above the meandering river below. The entrance to the Ardèche Gorge is through the famous Pont d'Arc near Vallon, which, at 192 feet, is, according to the Natural Arch and Bridge Society, "the largest natural bridge in Europe". You will take the famous Gorge Trail, from which you can gaze upon the harmonious meanderings of the river. Viewpoints such as the Pont d'Arc and Serre de Tourre offer the most remarkable vistas of the canyon and the Ardèche River.

Duration: approx. 4,5 hrs *Walking grade: ●●* € 59,00

GRIGNAN WITH TRUFFLE FARM AND TASTING

Join our local guide for a fun-filled journey starting from Châteauneuf-du-Rhône. The coach will take you to the medieval village of Grignan, located near Mont Ventoux – the highest mountain in Provence and featuring a Renaissance castle towering high above the town. With more than 60% of the national production of black truffle, Pays de Grignan, Enclave des Papes, and Tricastin form the center of world production. Visit a traditional truffle farm for a tasting and discover the fascinating and mysterious world of the black truffle.

Duration: approx. 4,5 hrs *Walking grade: ●●●* € 85,00

FRANCE: Seine

PAINTERS' VILLAGE AUVERS-SUR-OISE

Barely 30 minutes away from the bustling city of lights, the quaint village Auvers-sur-Oise is tucked away between the river Oise and a chain of rugged cliffs. During la belle époque, Auvers-sur-Oise was home to many painters such as Cézanne, Daubigny and Pissarro and today mostly famous for being the resting place of Vincent Van Gogh and his brother Theo. Immerse yourself in the life and legacy of this extraordinary artist and visit Van Gogh's burial place, located in the cemetery on a hilltop in the village.

Another highlight of the tour is a visit to the Château d'Auvers, built in the 17th century and immortalized by Van Gogh in his paintings. Join an immersive, multimedia experience, that shows what inspired Impressionism and takes you back to the era of the famous painters at the end of the 19th century.

Please note: From June to October 2023, the Château d'Auvers will be closed in preparation for an upcoming exposition of Van Gogh. During this period, you will alternatively visit the inn "Auberge Ravoux", where Van Gogh spent the last 70 days of his life, producing almost a painting each day.

Duration: approx. 4,5 hrs *Walking grade: ●●●* € 120,00

ROUEN WALKING TOUR

Historical capital of Normandy and a prosperous medieval city, Rouen is known for its many monuments and architectural treasures. The historic city center is a "must-see". Don't miss its fascinating heritage of Gothic churches and restored mansions, half-timbered houses and well-maintained public gardens. Visit the interior of the cathedral that inspired Claude Monet and the modern Church of Joan of Arc with its magnificent 16th century stained-glass windows. Learn about the historical legacy of this city, made famous by such figures as the Vikings, the Dukes of Normandy, Joan of Arc, the writers Corneille and Flaubert and the artists Géricault and Monet.

Continue to the "Gros Horloge", the astronomical clock, pride of the Rouennais, and the Parliament of Normandy, one of France's rare civil constructions in Gothic style in the late Middle Ages. The striking, flamboyant Church of Saint-Maclou dedicated to a Breton saint and known as Malo is one of the best examples of Gothic architecture in Rouen. Spend your free time at the "Place du Vieux Marché", the site where Joan of Arc was burnt at the stake.

Duration: approx. 2 hrs *Walking grade: ●●●●* € 24,00

PRESSOIR D'OR AND FREE TIME IN LYONS-LA-FORÊT

This afternoon discover a typical farm of Vexin Normand with its 17th century half-timbered buildings. Le Pressoir d'Or in Boisemont is not just a cider house. It's a journey through time and taste. The visit will include the Orchard, the cellar and a museum dedicated to old apple press and will end with a tasting of their production: cider, apple juice, apple jelly, cider confit, Pétill'Pomme. End your day enjoying some free time in Lyons-la-Forêt, ranked as one of the most beautiful villages of France. Built on the site of a former fortress and featuring remarkable centuries-old architecture, this charming picturesque village, hidden in the heart of one of the oldest and largest forests of Normandy, will invite you to simply wonder through the streets admiring half-timbered houses covered with flowers, antiques shops and cozy tearooms.

Duration: approx. 3,5 hrs *Walking grade: ●●●* € 79,00

ÉTRETAT – CLIFFS AND WALKING TOUR

Located on the coast of Normandy, 20 kilometers (twelve and a half miles) north of Le Havre, Étretat is renowned for its coastal scenery, in particular its white cliffs. Both the cliffs and the village are scenic highlights of the region and should not be missed. Join us to feel the magic of this place, full of history and legends. This exceptional natural site will take your breath away. Begin with stunning views of the cliffs and rock formations from the clifftop path.

Continue with a guided walking tour of the town. Historically a fishing

FRANCE: Rhône · Saône

MÂCON AND THE BEAUJOLAIS

With its pastel buildings and tiled roofs, the town of Mâcon has a Mediterranean charm. The tour crossing the Beaujolais and Mâconnais region will captivate you. While crossing the prestigious vineyards, discover the castles and mansions that witness this region's wealth. The highlight of this excursion is the visit to Georges Duboeuf's Wine Theme Park. In an original setting, a reconstruction of a 1900-style train station, discover splendid exhibition halls related to the history and culture of the winemaking process. Learn about wine growing from audiovisual shows: theater, winery trading house, 3D film, and dynamic cinema.

Finish the visit with a tasting of Beaujolais wines in a Parisian cabaret-style room housing a barrel organ called "Bouteillophone".

Duration: approx. 3,5 hrs *Walking grade: ●●* € 89,00

VISIT TO CLUNY ABBEY

The Abbey of Cluny in Burgundy was the center of a major monastic movement in the Middle Ages. Its church was the most prominent Christian building in the world until St. Peter's Basilica was rebuilt in Rome in the 16th century. Although most of the great Abbey of Cluny is in ruins, you can still see remnants showing the size and glory the abbey possessed at its zenith, and imagine it as it once was.

Today, one transept of the 12th-century abbey church remains, along with the 15th-century abbots' residences and 18th-century convent buildings. The site also includes magical gardens and a museum with Romanesque artifacts. The ancient Benedictine abbey, with its unusual dimensions, was completed under the abbacy of Pierre the Venerable and consecrated in 1130. The principal architect was Hézelon de Liège. The idea for its construction is said to have originated from a monk's dream.

Duration: approx. 3,5 hrs *Walking grade: ●●* € 76,00

CHÂTEAU DE PIERRECLOS WITH WINE TASTING

Our excursion takes us through the vineyards of the Beaujolais and Mâconnais wine regions. We pass castles and chateaux that bear witness to the area's wealth. Visit the Château de Pierreclos and learn about its oldest surviving sections dating back to the 12th century. Immerse yourself in medieval life and explore the vaulted cellars in the artillery tower, the armory, or the dungeon. Walk on the terrace overlooking the vineyards and experience a journey back to the 15th century. Finally, enjoy a tasting of local wines and cheeses.

Duration: approx. 3,5 hrs *Walking grade: ●●●* € 70,00

BEAUNE AND THE BURGUNDY

After breakfast, take a scenic drive along France's Burgundy wine route through Pommard, Volnay, and Meursault. In Beaune, the wine capital of Burgundy, enjoy a guided tour of the historic Hôtel-Dieu, founded as a hospice in 1443. Today, it covers a large area of the town with its museum, three courtyards, outbuildings, 15th-century bastion,

village with medieval houses and fishing cottages, Étretat became a popular seaside resort during the 19th century. Its popularity was enhanced by the large number of famous artists and authors who were inspired by Étretat. Monet, Maupassant, Victor Hugo and Flaubert were all lovers of the region around the town. Monet painted several well-known paintings of the coast and cliffs around Étretat.

Enjoy some leisure time in this attractive small town to explore. From the pebble beach and the promenade you can enjoy the cliffs on either side once more.

Duration: approx. 4 hrs *Walking grade: ●●* € 63,00

HONFLEUR – CITY OF ART AND HISTORY

Follow your guide and enjoy a stroll through the charming city of Honfleur. This gorgeous maritime city is a town of painters and Impressionism, and possesses that something extra that makes it irresistible. The changing light on the Seine estuary inspired Courbet, Monet, Boudin and many others. Your guide will lead you through its narrow streets, steeped in history, and in the footsteps of sailors, painters, artists and musicians. Stop at the world-famous Vieux Bassin (old port), the Lieutenancy building, from which Samuel de Champlain set out to discover Canada, the old salt stores and St. Catherine's Church, with its unusual architecture and separate bell tower built by sailor-carpenters. Today, dozens of galleries and artists' studios continue to display a wide range of classical and modern paintings. Honfleur is also the perfect place to find local arts and crafts and specialties such as cider, Calvados, caramels and more.

Visit the local market or just spend your free time in one of the small cafes and enjoy the beautiful atmosphere.

Duration: approx. 4 hrs *Walking grade: ●●●●* € 63,00

FULL-DAY "FASCINATING NORMANDY" WITH LUNCH

Join us on a fascinating Norman journey, a land of farmlands, beaches, bucolic sceneries and picturesque half-timbered houses, but also the backdrop to the WW II tragic events. Its rich culinary tradition is based on fine local products like world-famous cheeses and cider apples varieties. Normandy boasts many historic landmarks, such as the city of Arromanches, the closest harbor linked with the liberation of Western Europe after D-Day. The staggering big concrete blocks remaining from the Mulberry artificial Harbor bring the massive Allied operations here back to life. Continue your morning at Longues-sur-Mer with its artillery battery. It has the only German coastal defense battery classified as an historic monument on the D-Day landing beaches. Savor a traditional Norman lunch break in Bayeux facing the famous cathedral. Step into the story of the remarkable ascent of the Duke of Normandy, William the Conqueror in the city of Bayeux. The city boasts a fabulous historic center as well as its world-famous, UNESCO-listed 270-foot-long tapestry depicting the Norman conquest of England in 1066.



Château de Malmaison

In the afternoon, enjoy a visit to a traditional distillery in the heart of Pays d'Auge. Taste the famous Calvados and discover the richness of this brandy, its history and production secrets. Rejoin the ship in Caudebec.

Duration: approx. 11 hrs *Walking grade: ●●●●●* € 205,00

FÉCAMP WITH PALAIS BÉNÉDICTINE

Fécamp is a seaside resort on the alabaster coast in the department of Seine-Maritime, surrounded by the tallest cliffs in Normandy. An attractive setting, the city became a favorite with the Dukes of Normandy and was their home until 1204. This quintessential fishing port has beautiful seaside resorts, a religious pilgrimage site and is home to the famous Bénédictine liqueur. Enjoy a visit to the Palais Bénédictine, a Gothic-Renaissance architectural masterpiece. The palais was built at the end of the 19th century for Alexandre Le Grand, a wine merchant from Fécamp who rediscovered a recipe for Bénédictine, which was left at the Abbey by a Venetian Monk, in the 16th century. Le Grand began producing the liqueur and claimed it to have medicinal properties – creating a bestseller. View the extraordinary art collection from the 15th and 16th century left by Alexandre Le Grand, and visit the only distillery in the world still in operation producing the Bénédictine liqueur.

Duration: approx. 3,5 hrs *Walking grade: ●●●* € 80,00

MONET'S MUSES & CHÂTEAUX GAILLARD

Step into the past with a short drive to the white stone remains of the English king's stronghold: Château Gaillard. It was built at the end of the 12th century on a limestone promontory, overlooking the Seine. You'll be rewarded with stunning views of the river and surrounding countryside. Our expert tour guide will share stories of the erection of this fortified castle by Richard Lionheart and of how Blanche and Marguerite, the adulterous daughters-in-law of the king, were imprisoned here.

Continue to Giverny, its vividly colored flora and gentle atmosphere being a source of inspiration for one of the foremost Impressionist painters: Claude Monet. As he glanced out of the window of his train and caught sight of the village, he decided then and there that this was where he wanted to live and work. And so he did, from 1883 until his death in 1926. Enter the intimate world of this great epicurean. Hear about the affection Clemenceau had for his friend and about the exchanges and verbal jousts with contemporaries Berthe Morisot, Marie Cassatt and Paul Cézanne. Tour the various rooms reflective of the personality of Monet.

Duration: approx. 4 hrs *Walking grade: ●●* € 97,00

JOSÉPHINE, NAPOLEON AND CHÂTEAU DE MALMAISON

The former residence of Joséphine and Napoleon Bonaparte lies in West of Paris, surrounded by an idyllic green setting. The "small" mansion purchased by Joséphine de Beauharnais in 1797 was just a run-down estate in desperate need of care and devotion when she set her eyes on it while her husband Napoleon was off fighting in Egypt. And that is precisely what Joséphine brought to the property, transforming it into a "source of riches for all of France". Napoleon Bonaparte took there many major decisions for France from 1800 to 1802. Joséphine continued to live in here even after her divorce and did not cease to develop it until her death, turning the rooms and park into a real gem of the First Empire period.

Your Guide will lead you in the discovery of their daily life during the consulate and First Empire. Discover the music room and the council room shaped like a military tent where receptions, dances and country-style games took place. Visit Joséphine's bedroom where she died in 1814, passing through the Marengo room with weapons that belonged to Napoleon.

Enjoy some free time in Joséphine's cherished gardens. Nostalgic for the luxurious island of her childhood, she wanted to replicate the landscape of her native land Martinique with its rich flowers and birds. She called upon Europe's best gardeners and soon bundles of flowers arrived from all over the continent. Daffodils, hyacinths, camellias

and tulips still flourish in her garden. The property achieved enduring fame for its rose garden, where Joséphine grew all varieties of roses known at the time.

Duration: approx. 4,5 hrs *Walking grade: ●●* € 88,00

PARIS – CAFÉS, CATHEDRALS & CITY OF LIGHT

Josephine Baker sang "J'ai deux amours, mon pays et Paris", referring to her two great loves: her country and Paris. She sums up how most people feel when visiting the French capital, which is one of the most romantic and fascinating cities in the world. The endless number of things to do and places to see means that everyone can find something fascinating to discover in this singular, magical and majestic city. Let your imagination wander as you pass through the streets of this capital, imbued with the memory of those who shaped the history of France: Joan of Arc, Louis XIV, Louis XVI and Napoleon Bonaparte. Learn about the daily life of Parisians, and find out the secrets and marvels of the "City of Lights".

The sightseeing program includes the incomparable Eiffel Tower, Les Invalides, famous as the burial place of Emperor Napoleon I, the fabulous Louvre Museum, the famed and elegant Champs-Élysées, the Jardin des Tuileries, former palace gardens laid out in the French style and much more.

Duration: approx. 3,5 hrs *Walking grade: ●* € 63,00

MONTMARTRE WALKING TOUR

The hill "la butte Montmartre" is located in the 18th arrondissement and boasts a magnificent, panoramic view of Paris. With its narrow, winding streets peppered with steep stairways and charming lamp-posts and its cobbled squares filled with watercolor painters and sketch artists, Montmartre is the picture-postcard idea of Paris. It includes the hillside vineyard on the Rue des Saules, the festive Moulin de la Galette, where Renoir came to paint in the open air, and the Bateau Lavoir studio. Stroll through the sinuous streets of the tallest hill of the capital with your guide, just like artists such as Picasso, Renoir, Toulouse-Lautrec and Utrillo have done since the end of the 19th century. Sense the contrasts of this legendary and picturesque place, where wine flowed freely and romance alternated with madness.

Duration: approx. 3 hrs *Walking grade: ●●●●* € 67,00

GERMANY

BAMBERG WALKING TOUR

A comfortable coach will take you into the center of Bamberg, affectionately known as the "Frankish Rome". The walking tour will enable you to immerse yourself in the magic and history of this town. With its historic old quarter, its churches and monasteries, bridges, narrow streets and squares, its half-timbered houses and baroque facades, it has been declared a World Cultural Heritage Site by UNESCO. See magnificent sights such as the imperial cathedral, the old imperial residence, the new residence palace and rose garden, the old town hall and the former fishing district that is now Bamberg's "Little Venice" area.

Duration: approx. 3 hrs *Walking grade: ●●●●* € 34,00

BERNKASTEL WALKING TOUR WITH WINE TASTING

Get to know medieval Bernkastel-Kues during an entertaining guided tour of the old town. You will learn many endearing facts about the town as well as interesting facts about the landscape and wine culture. In front of the St. Nicholas Hospital you will receive an explanation of the famous philosopher's ball game and may also try it out yourself. At the end of the excursion there will be a short walk through the vineyards and you will enjoy two wines in a historical building. One of the a glass of wine is the world famous Bernkasteler Doctor wine. Under the motto "Wine & Health" you will learn why not only the Doctorwein can have a health-promoting effect.

Duration: approx. 2,5 hrs *Walking grade: ●●●●* € 46,00

COCHEM WALKING TOUR & REICHSBURG CASTLE

A harmonious triad of unique Moselle landscape, millennia-old wine culture and history make Cochem a popular destination. Discover the town with its narrow, winding streets during a city tour. Next, visit the Reichsburg castle which dominates the landscape due to its size and its location on a rugged rock high above the town. Enjoy views over the Moselle Valley, with its dreamy mixed forests and terraced vineyards, as well as the old town. Inside the castle you will find a collection of Renaissance and Baroque furniture, as well as other treasures, carefully collected by the Ravené family who owned the castle until 1978, when it was turned over to the town of Cochem, for all to enjoy.

Duration: approx. 3 hrs *Walking grade: ●●●●* € 45,00

TASTING OF TYPICAL MOSELLE WINES IN A LOCAL WINERY

Visit one of the wineries located directly in the town of Cochem and learn more about viticulture and wine cellar management. The Moselle region is famous for its top wines with the most traditional grape variety being the Riesling, which is also called "the queen of white wines" and is grown directly on the sunny slopes of Cochem. During the excursion you can taste different Moselle wines and learn more about the winemaking process.

Duration: approx. 1,5 hrs *Walking grade: ●●●●* € 18,00

COLOGNE WALKING TOUR AND KÖLSCH TASTING

The cathedral city dates back over 2,000 years and is full of history, the traces of which can be seen everywhere in the Rhine region. During the walking tour, explore the area around the cathedral all the way to the old town. As you travel through the narrow, cobbled streets, and the lively squares such as the "Alter Markt" or the "Heumarkt", you will get a feel for life in Cologne from yesterday and today. Since its completion in 1880, the Cologne Cathedral with its two 515 ft high towers has been the city's landmark, as well as the most famous architectural monument and most frequently visited sight in Germany.

As your excursion concludes, we invite you to enjoy a glass of typical Kölsch (beer), which is the number one beer in Cologne and large parts of the Rhineland.

Duration: approx. 2,5 hrs *Walking grade: ●●●●●* € 44,00

SIEBENGEIRGE AND DRACHENFELS CASTLE RUINS

From Cologne travel by coach southward, passing by Germany's former capital Bonn and head towards Germany's first nature reserve, called "Siebengebirge" (Seven Mountains). On the top of this summit you will find the Hotel Petersberg where many important political meetings, such as the Afghanistan conference in 2001, took place. You can reach the summit with Germany's oldest rack railway or on foot, to then explore the remains of Castle "Drachenfels" (Dragon Rock) and enjoy the wonderful views into the valley "Rheintal". About halfway up the Drachenfels, you will find the Nibelungenhalle, opened in 1913 for the 100th anniversary of the famous composer Richard Wagner. The domed building in Late Art Nouveau style shows mystical paintings of the glorious Nibelungen saga.

Duration: approx. 4 hrs *Walking grade: ●●●* € 81,00

FREIBURG – CAPITAL OF THE BLACK FOREST

Depart Strasbourg and travel overland to the jewel of the German Black Forest, Freiburg, which offers the perfect combination of city experience and nature, as well as culinary delights. Freiburg was founded in 1120 as a 'free market' by the dukes of Zähringen, hence the name. The city was passed through many hands, the Habsburgs, the Swedes, the Bavarians and the French, and finally returned to the ruling house of Baden in 1806. Experience centuries of Freiburg's history along with the famous 'Freiburger Bächle', an open stream system which has been flowing along the streets with crystal clear water since the Middle Ages.

Walk through secluded alleys, across beautiful squares, past historic façade to the gothic Minster with its stain glass windows and 380



© S. Benson/Shutterstock.com

Heidelberg

foot spire – the tallest of its kind ever built. Finally, experience the traditional Freiburg Minster Market where a wide selection of local products will tantalize the senses. On the days when the market is not open, conclude the tour with a visit to the Minster.

Duration: approx. 4 hrs *Walking grade: ●●●* € 46,00

ROMANTIC HEIDELBERG WITH THE CASTLE RUINS

A comfortable coach will take you to Heidelberg, the world famous University City. The town is one of the few German cities with a widely preserved baroque Old Town. Heidelberg was discovered quite early by romantics to use for diverse literature, songs and paintings. The tour through Heidelberg begins with a visit to the castle. The formerly splendid residence made of red sandstone has been a ruin, maybe the most beautiful ruin in all of Germany. The castle tour leads also into the castle garden. From the Grand Terrace you will have a wonderful view of the city and the Neckar River. The tour continues with a stroll through the enchanting old town, to the Karl-Theodor Bridge, the late-gothic Church of the Holy Spirit and the town hall.

Duration: approx. 4,5 hrs *Walking grade: ●●●* € 64,00

HEIDELBERG CASTLE AND CHRISTMAS MARKET

[See description "Romantic Heidelberg with the castle ruins"]

At the end of the tour there will be time to stroll through the Christmas market.

Duration: approx. 4,5 hrs *Walking grade: ●●●* € 64,00

KOBLENZ WALKING TOUR

Discover one of the most pedestrian-friendly and oldest towns in Germany, with over 2,000 years of history. On our guided walk through the romantic streets between the St. Castor Basilica and the Liebfrauenkirche (the Church of our Beloved Lady) you will discover the most important sights of Koblenz and the town's landmark, the Schängel Fountain at the town hall. This tour would not be complete without a visit to the Memorial of Emperor Wilhelm at the famous German Corner where the rivers Rhine and Moselle meet. See the cable car that hovers over the Rhine, built as an attraction and ecologically friendly traffic facility for the Federal Horticultural Show in 2011. This is Germany's first 3-rope cable car with a transport capacity of 7600 people per hour.

Duration: approx. 2 hrs *Walking grade: ●●●●* € 24,00

KOBLENZ WALKING TOUR WITH EHRENBREITSTEIN FORTRESS

Discover Koblenz, one of the most beautiful and oldest cities in Germany with more than 2,000 years of history. During a walking tour in the romantic side streets between the Basilica of St. Kastor and the

Church of Our Lady, view the most important sights of Koblenz. Continue your excursion by cable car, built for the International Garden Show, high above the Rhine to the impressively situated Ehrenbreitstein Fortress. Ehrenbreitstein Fortress is the second largest preserved fortress in Europe. The fortress dates back to 1,000 AD and evolved to its present form between 1817 and 1828. Today, the fortress houses the Koblenz State Museum with its diverse exhibitions including the history of the fortress, the Army Memorial and a youth hostel.

Duration: approx. 3 hrs *Walking grade: ●●●●●* € 52,00

EHRENBREITSTEIN FORTRESS IN KOBLENZ

After a short walk through Koblenz, discover Ehrenbreitstein Fortress, situated high above the Rhine. The bottom station of the cable car, which was built especially for the International Garden Show, gives you the most fantastic views over Koblenz and the confluence of the Rhine and Moselle rivers. The fortress dates back to 1,000 AD and evolved to its present form between 1817 and 1828. Today, in addition to the Koblenz State Museum with its diverse exhibitions (e.g. on the history of technology and archaeology of the state, fortress history with over 20 exciting stations, multimedia productions and much more), the fortress also houses the Army Memorial and the Koblenz Youth Hostel.

Duration: approx. 2 hrs *Walking grade: ●●●●* € 52,00

MAINZ WALKING TOUR WITH THE GUTENBERG MUSEUM

Mainz has many attractions: the Roman Castrum Moguntiacum, the Jewish Magenza, the residence and capital of the Prince Electors, an archbishopric, a university town and a fortified city of the Holy Roman Empire, as well as the Mainz Republic. These are all epochs of "Golden Mainz", as the city has been known since its heyday in the Middle Ages.

A tour through the city will lead you from the tremendous St. Martin's Cathedral to the Gutenberg museum, where you can experience 4000 years of the history of writing. The museum is a tribute to the inventor of the printing press with moveable letters. His world renowned 42-line bible is one of the prime exhibits.

Duration: approx. 2,5 hrs *Walking grade: ●●●●* € 24,00

EVENING EXCURSION TO FRANKFURT WITH VISIT TO AN APPLE FARM AND TASTING

Transfer with the bus from Frankfurt to the cider manufacture 'Am Steinberg', just outside of Frankfurt. The farm was founded 1965 by Albert and Waltraud Schneider. 1996 the son of the founders, Andreas turned the agricultural business into an organic farm. The farm received already 3 times the POMME D'OR award, which is known as the Oscar among the cider manufactures. You will be equipped with a torch and guided through the apple plantation.

Meanwhile the guide tells you more about the philosophy and the history of the farm, you are welcome to enjoy a warm cup of cider. The visit of the farm will last 45–60 minutes. After the visit the bus will drive you back to the ship.

Duration: approx. 3 hrs *Walking grade: ●●●●* € 79,00

MILTENBERG AND WERTHEIM WITH GLASS MUSEUM (or vice versa)

Immerse yourself in the vibrant history and romance of Wertheim and explore the city with its medieval streets and numerous half-timbered houses. The Angel's Fountain and the Late Gothic Kilian Chapel are especially worth seeing, as well as the local glass museum. During a tour of the museum you will learn exciting stories about glass and you can observe glassblowers at work. (Note: Visits to the glass museum are subject to availability.)

The tour continues to the town of Miltenberg. A guided tour through the town will show you that Miltenberg offers a charming trio of river, medieval town and wooded hillsides. The historic market square, the high, gabled, half-timbered houses, the old town hall and the towering Miltenberg Castle are part of the charm of this German town.

Duration: approx. 4,5 hrs *Walking grade: ●●* € 48,00

MILTENBERG WALKING TOUR WITH GINGERBREAD AND WERTHEIM WALKING TOUR

Stroll into the small town of Miltenberg and discover the historic market square, the high-gabled half-timbered houses and the old town hall. The all-surmounting Miltenberg Castle provides the backdrop for this entertaining walking tour of the town, which ends with a tasting of gingerbread.

Afterwards, immerse yourself in the lively history and romance of the neighboring town of Wertheim and explore the medieval alleys and numerous half-timbered houses during the city tour. Worth seeing are especially the Angel Fountain and the Collegiate Church late Gothic Kilian's Chapel.

Duration: approx. 4,5 hrs *Walking grade: ●●* € 50,00

NUREMBERG – CAPITAL OF FRANCONIA

The city tour leads you to the major sites and highlights of the city, from its medieval beginnings to the present. Once a free imperial city of economic influence, Nuremberg is the second largest city in Bavaria. During the reconstruction work following the devastation of the Second World War, the style of the old town was maintained. Ringed walls, towers and the castle provide a vivid image of the town as it may have looked in the Middle Ages.

Enjoy a tour through this city and time at your own disposal in the historic city center (time permitting) before the coach takes you back to the ship.

Duration: approx. 4 hrs *Walking grade: ●●●●●* € 52,00

NUREMBERG WITH VISIT TO THE CHRISTMAS MARKET

[See description "Nuremberg – Capital of Franconia"]

Before returning to the ship, enjoy a stroll through one of the most famous Christmas markets in the world. Here Christmas is at home, with original gingerbread and mulled wine.

Duration: approx. 4 hrs *Walking grade: ●●●●●* € 52,00

THE DOCUMENTATION CENTER OF NUREMBERG

The Nazi party's rallying grounds are in the southeast of Nuremberg, where Nazi rallies were held from 1933 to 1938. To this day, the remains of the buildings with their immense proportions are a vivid testimony to the megalomania of the National Socialist regime. This area of eleven square kilometers served as an impressive backdrop for the Nazi party rallies, staged here to demonstrate their power.

Today, the area includes a memorial site and is used as the Norisring motor racing track. You will visit the grounds and the documentation center with the permanent exhibition, "Fascination and Violence", that looks at the causes, the context and the consequences of the National Socialist reign of terror.

Duration: approx. 3 hrs *Walking grade: ●●●* € 64,00

VISIT TO THE WORLD OF GINGERBREAD

No trip to Nuremberg is complete without tasting the world famous 'Lebkuchen' or gingerbread. Lebkuchen was invented by monks in the 13th century in Franconia, Germany and recorded as early as 1395 in Nuremberg.

Today, Nuremberg is the most famous exporter of the product known as Nuremberg Lebkuchen – gingerbread decorated with almonds. During this excursion, visit the Nuremberg Gingerbread and Pastry Specialties shop – Schmidt. Over coffee and samples fresh from the oven, a short film will introduce you to the realm of the sweet delicacy made of honey and spices.

Duration: approx. 2 hrs *Walking grade: ●●●●●* € 47,00

OBERWESEL WALKING TOUR

Welcome to the "City of Towers", Oberwesel. From far away you can see the silhouette of Schönburg, the Church of Our Lady and its defensive wall with many towers. The medieval influence still visible in Oberwesel makes it a town like no other in the Middle Rhine Valley. Explore the monument area and learn more about the history of Oberwesel on a guided tour. The town walls remain largely intact

in their original medieval form, and may give you an idea of what their circularity meant to people in times gone by. Catch a glimpse of the beautiful surrounding gardens and the former Franciscan Minorite Monastery.

Duration: approx. 1,5 hrs *Walking grade: ●●●●●* € 24,00

PASSAU WALKING TOUR

Join us on a walk through the old city of Passau. The baroque city on three rivers has long been a magnet for traders and travelers. It will astonish you from your first moments in its winding streets. In the heart of the Old Town lies its most known site – St. Stephen's Cathedral, often known as a baroque cathedral with a gothic soul. The organ in Passau's cathedral is considered to be the largest Catholic church organ in the world and the largest organ in Europe. High above the Old Town sits one of the largest fortress complexes in all Europe – the Veste Oberhaus which can be discovered on your own at the end of the walking tour. Accessible via the exterior walls, never conquered, never completely destroyed: it is a prime example of long term historical construction.

Duration: approx. 2 hrs *Walking grade: ●●●●●* € 24,00

PASSAU WALKING TOUR WITH ORGAN CONCERT IN THE CATHEDRAL

[See description "Passau walking tour"]

Afterwards you will enjoy an organ concert in the cathedral (depend on the opening hours and the celebration of mass).

Duration: approx. 3 hrs *Walking grade: ●●●●●* € 30,00

REGENSBURG WALKING TOUR

Discover one of the best-preserved medieval cities in Germany. Among its architectural gems are churches, monasteries, the town hall and one of Europe's oldest bridges that has spanned the Danube since the 12th century. On this walk you will feel the former power and wealth of this city, which once controlled the trade route to the Orient. During a short visit to the Regensburg Cathedral, dedicated to St. Peter, you can admire this masterpiece of Gothic architecture in southern Germany. (Visits depend on the opening hours and the celebration of mass.)

Duration: approx. 2 hrs *Walking grade: ●●●●●* € 24,00

MEDIEVAL ROTHENBURG OB DER TAUBER

Rothenburg is referred to as Germany's well-preserved "Jewel of the Middle Ages" with its ramparts, city gates, town hall and the St. Jakob Parish Church. Renaissance and Gothic influences shaped the town. Towers, city gates, walls, half-timbered gables – all these have remained unchanged since the Thirty Years' War. The Middle Ages come alive in Rothenburg! Upon your arrival, join the town walk with a local guide who will point out major points of interest. Pass by the St. Jakob Parish Church, where art lovers can admire the "Heiligblutaltar" (Holy Blood Altar) by Tilman Riemenschneider, one of the greatest German sculptors of the Middle Ages.

After the guided tour, visit the famous church or the Christmas Museum of Käthe Wohlfahrt on your own, enjoy some free time and buy souvenirs.

Duration: approx. 4 hrs *Walking grade: ●●●●●* € 45,00

RÜDESHEIM WITH MUSIC CABINET MUSEUM

The unique Winzerexpress train takes you from the dock of the ship to the "Siegfried Mechanical Music Cabinet" for a musical adventure with historical self-playing instruments.

Continue your guided tour with a walk through the picturesque town. Explore the heart of the old town of Rudesheim – the 'Drosselgasse' – where wine houses and garden taverns invite you to linger. Immerse yourself in the history of the city and visit the Eagle Tower, a part of the city wall, and the fortifications from the 15th century.

Duration: approx. 2 hrs *Walking grade: ●●●●●* € 33,00



Trier: Porta Nigra

© iStockphoto.com / Shutterstock.com

SPEYER WALKING TOUR & THE IMPERIAL CATHEDRAL

Speyer, the time-honored imperial city on the Rhine, looks back on a rich and eventful past. Historic testimonies of ecclesiastical architecture, façade of different building epochs, winding alleys and romantic squares characterize the face of the city today. Start with a guided tour of the Romanesque Imperial cathedral with its striking twin-towered portal, and visit the revered baroque Church of the Holy Spirit, the Old Gate of Speyer and a visit to the medieval Judenhof, one of the most important Jewish medieval sites in Germany. The Jewish community had a storied history in Speyer reaching back over 1,000 years.

View the remains of the Jewish courtyard, which was the central area of the Jewish quarter and consisted of the synagogues, and a ritual bath (Mikveh). (depending of opening hours, Mass times, etc.)

Duration: approx. 2,5 hrs Walking grade: ●●●● € 29,00

SPEYER WALKING TOUR WITH CHRISTMAS MARKET

Speyer, the venerable emperor's city on the Rhine, has had a rich and turbulent past. Religious architecture steeped in history, impressive facades of various styles, winding alleys and romantic squares express the character of the city. The city tour includes a visit to the Romanesque Imperial Cathedral from the exterior, with its striking twin tower portal, and visits to the Church of the Holy Spirit, the Old Gate (Altpoertel) and the Jewish Ritual Bath.

Afterwards, the Christmas market will fill you with warmth as the smell of punch and toasted almonds, hot roasted chestnuts and freshly baked apples envelopes your nose.

Duration: approx. 2 hrs Walking grade: ●●●● € 29,00

THURN & TAXIS PALACE, BREWERY WITH TASTING

The palace is a must-see and is said to have more rooms than Buckingham Palace in London. With roots in German nobility, it was built in the 18th century. During the guided tour, view the marble staircase in the south wing of the palace, which leads to the magnificent rooms of the princely residence. The entire neo-Renaissance style interior is modeled after Roman antiquity.

Afterwards, visit the traditional brewery at the castle, for a short guided tour followed by a beer sampling and typical Bavarian pretzel.

Duration: approx. 3,5 hrs Walking grade: ●●●● € 76,00

THURN & TAXIS PALACE AND CHRISTMAS MARKET

Enjoy magical and unforgettable moments at the "Romantic Christmas Market" at the Thurn and Taxis Castle of Regensburg. A short visit to the palace shows you the gorgeous marble staircase in the south wing, ascending to the splendid chambers of the princely residence. Guests are traditionally greeted at the foot of the impressive staircase. The entire interior decoration in Neo-Renaissance style is modeled on Roman antiquity. In the courtyard of the palace you will see the beautifully decorated and wood-fire heated huts that are the perfect place to pass the time. The bough-covered wooden stalls offer unique products, obviously chosen for their quality and beauty. It's one of the most beautiful Christmas markets in the world.

Duration: approx. 2,5 hrs Walking grade: ●●●● € 76,00

TRIER – GERMANY'S OLDEST CITY

Get acquainted with the oldest city in Germany! Pass the Porta Nigra, an unforgettable landmark and largest Roman city gate north of the Alps. Experience even more awe-inspiring Roman buildings while on your tour such as the late-Romantic Three Kings' House from the 13th century, the medieval-style Main Market Square, St. Peter's Cathedral, and the Church of Our Lady. Your excursion ends at the Kornmarkt. A main feature of the square is its neoclassical casino where influential residents, like Karl Marx's father, would gather. While at the Kornmarkt, don't miss the lovely St. George's fountain, one of the most beautiful fountains in Germany. Standing at 36 feet tall, the Rococo style structure artfully represents the four seasons. Complete your exploration with a bite at one of the numerous restaurants or by taking a stroll through the bustling, yet relaxed square.

Duration: approx. 3 h Walking grade: ●●●● € 52,00

DANUBE GORGE, WELTENBURG ABBEY & BEER TASTING

A coach brings you to Weltenburg, with a brief detour to the "Hall of Liberation", a time-tested, classical monument on Mount Michelsberg, above the city of Kelheim. This impressive marble building is fashioned after the Parthenon in Athens. It towers high above the Danube and can be seen from afar. Afterwards, board an excursion boat which will take you past the former city of the Wittelsbacher Dynasty and through the nature reserve "Weltenburger Enge" to the Benedictine abbey of Weltenburg. The monastery, founded by Irish or Scottish monks in about 620 AD, is the oldest monastery in Bavaria. After a short tour of the abbey church taste the famous dark beer of Weltenburg, which is brewed here in the oldest monastic brewery in the world.

Duration: approx. 5 hrs Walking grade: ●●●● € 78,00

VISIT TO WELTENBURG ABBEY

This Benedictine abbey in Lower Bavaria is located on the banks in the Danube loop at the mouth of the romantic Danube Gorge. The abbey was founded about the year 620 by missionary monks and is the oldest monastic settlement in Bavaria. The baroque abbey church dedicated to Saint George was built between 1716 and 1739 and later embellished by the Asam brothers. Immerse yourself in the history of the monastery and learn more about the way of life of the monks, the Benedictine life and the construction of the monastery in this magical setting.

Duration: approx. 3,5 hrs Walking grade: ●●●● € 45,00

WÜRZBURG WALKING TOUR WITH RESIDENCE AND WINE TASTING

Start your tour with the visit to the Würzburg Residence, a masterpiece of the southern German Baroque style. Former residence of the Würzburg prince-bishops, its design is over-the-top luxurious. The central staircase with frescos by the Venetian Tiepolo and the Imperial Hall are particularly impressive. Afterward, enjoy a walking tour through the ancient episcopal city of Würzburg which looks down on the broad stream of the Main river and is surrounded by hills on all sides. The old town features many sights such as the marketplace, the Maria Chapel and the old Main bridge, with its unique panorama of Marienberg – a fortress for princes of the Church – and the surrounding vineyards. At the end of the tour, you will have the chance to taste a glass of wine.

Duration: approx. 3,5 hrs Walking grade: ●●●● € 69,00

HUNGARY

BUDAPEST – CASTLE HILL & HISTORIC WONDERS

Budapest, the "Queen of the Danube", is one of the most beautiful cities in the world and has managed to retain a charm of its own with the help of renovations in recent years. The Danube flows through the heart of the city, dividing it into two parts: Buda and Pest. The tour first takes you through Pest, past the Great Market Hall with its outstanding gourmet shops and stalls. You will see splendid Baroque

sights such as the Hungarian State Opera in Neo-Renaissance style and the incomparable parliament building, which was finished in 1904 and has been iconic ever since. There's an opportunity for a photo stop at the Heroes' Square, famous for its monuments to many Hungarian kings. Continue across one of the seven bridges into Buda and go up to Castle Hill, where you will visit St. Matthew's Church and the famous Fisherman's Bastion (provided that it is open to the public). Enjoy the unforgettable view over the city before returning to the vessel.

Duration: approx. 3,5 hrs Walking grade: ●●●● € 45,00

ESZTERGOM, VISEGRÁD CASTLE AND SZENTENDRE

Esztergom, the former residence of the Hungarian kings and seat of the Archbishop, is one of the highlights of this excursion. Your tour starts with a visit to the vast domed basilica, the largest cathedral in Hungary. Built in the early 19th century, it incorporates an ornate red marble chapel from an earlier church.

Then, continue along the riverbank to the imposing ruined fortress of Visegrád where you have a glorious view of the "knee" of the Danube. Your next stop is the artists' village of Szentendre. Since the early 20th century, the town has been the home of many generations of Hungarian artists. There are many museums and contemporary galleries representing the rich traditions of visual arts. One of the most visited museums of the whole country, the Margit Kovács Museum, is also located here. Főter, the main square, is particularly well worth seeing. Continue south to Budapest along the scenic west bank of the Danube. The towns and villages peppering this stretch of the river are a popular retreat for the inhabitants of Budapest.

Duration: approx. 5 hrs Walking grade: ●●●●● € 58,00

SZENTENDRE, VISEGRÁD CASTLE AND ESZTERGOM

The tour departs from Budapest and takes you to the artists' village of Szentendre, home to many generations of Hungarian artists since the early 20th century. Many museums and contemporary galleries represent the rich traditions of the visual arts in this town. Works of the ceramist Margit Kovács (1902–77) are displayed in a famous, eponymous Museum. The focal point of Szentendre is Foetér, the main square, lined with eateries, cafes, and souvenir stores.

Continue to the imposing ruined fortress of Visegrád, where you have a glorious view of the "knee" of the Danube. Next highlights of this excursion is Esztergom, the former residence of the Hungarian kings and seat of the Archbishop. Visit the vast domed basilica – the largest cathedral in Hungary. Built in the early 19th century, it incorporates an ornate red marble chapel from an earlier church.

Duration: approx. 5 hrs Walking grade: ●●●●● € 58,00

VISIT TO THE ROYAL PALACE OF GÖDÖLLŐ

Located close to Budapest, the palace was built in the 18th century. It was once the favorite summer residence of Empress Elisabeth and Emperor Franz Josef of Austria. In 1867, this noble estate was the coronation gift of Hungary to the royal couple. Nestled in an enormous park, it is the largest and most attractive complex of Baroque buildings in Hungary. In recent years it has been lovingly refurbished and you can visit the splendid ballroom with its marble stucco details, as well as the apartments of the royal couple.

Duration: approx. 3 hrs Walking grade: ●●●● € 59,00

TRADITIONS OF THE HUNGARIAN PUSZTA (from Mohács/to Kalocsa)

Drive to the Hungarian Great Plain to enjoy the scenery of the vast fields, where the sky stretches endlessly into the horizon, giving the impression of unlimited freedom. Enjoy the hospitality of the hostesses and riders wearing traditional costumes, quench your thirst with cool red or white wine or apple juice, taste the breakfast of Hungarian peasants and admire the galloping of the renowned Hungarian half-blood horses. Do not miss the carriage ride, which will complete the experience. Continue to the "Paprika House" to learn about how paprika became the "red gold" of the Kalocsa Region. Taste cakes and other foods filled and baked with paprika. Continue with a visit



Panoramic view of Budapest

© Emi Cristea/Shutterstock.com

to an upper-class 19th century farmer home. Enjoy a folk dance performance while local women in traditional dresses demonstrate the art of traditional embroidery and paint decorative eggs.

Duration: approx. 4 hrs *Walking grade: ●●* € 81,00

TRADITIONS OF THE HUNGARIAN PUSZTA (from/to Budapest)

As the coach drives you out of Budapest, take in the beauty of the countryside with typical villages and cultivated areas, while your guide gives you information on present day life in Hungary. Upon arrival, admire the fantastic relationship between Hungarian equestrians and their horses during a horse show. If you would like to ride a horse without saddle, you will have the chance after the show. Taste Hungarian salami and paprika and enjoy a glass of local wine in the Csárda restaurant of the farm.

At the end of the tour, our coach will bring you back to the vessel.
Duration: approx. 4 hrs *Walking grade: ●●* € 81,00

VISIT TO A 700 YEARS OLD MILL WITH OVEN PIE TASTING

The water mill monument in Mohács is one of the few of its kind where grinding is still carried out by means of millstones. A variety of tools can be tried out, showing the development of grain processing from prehistoric to modern times. An extraordinary sight at the mill building is the treadmill machinery driven by human power, which is unique in the whole world. At the end of the tour you will have the opportunity to taste one of the typical pies of the country before your bus will take you back to the ship.

Duration: approx. 2,5 hrs *Walking grade: ●●●●* € 55,00

AN AUTHENTIC TASTE OF BUDAPEST

Your spirited excursion begins with a visit to the Market Hall. Built in 1896, this imposing site is the oldest and largest indoor market in Budapest and offers a variety of Hungarian specialties such as tokaj wine, langos and Hungarian paprika. Next, you will continue by bus to the City Park, where you'll see the romantic Vajdahunyad Castle and the beautiful Széchenyi Baths – some of the largest and most popular thermal baths in Europe. Afterwards, ride the second oldest metro in Europe to the heart of the city and visit one of Budapest's numerous pastry shops, where you can enjoy a slice of fluffy cake and a cup of coffee, and finally view the astonishing St. Stephen's Basilica. (Alternative: On Saturdays and Sundays, the Market Hall is closed and the Basilica cannot be visited due to Holy Mass. Instead, we will visit the famous Budapest Opera House and drive up Gellert Hill to enjoy the spectacular view).

Duration: approx. 3 h *Walking grade: ●●●* € 48,00

LUXEMBOURG

GREVENMACHER AND THE LUXEMBOURG MOSELLE

Grevenmacher proudly looks back on its storied past, inviting you to unravel the richness of the fortified town before you on a cultural and historical tour. Begin at the old fortress tower, dating back to the 12th century, where you will learn about the town's 85-foot-tall landmark before making your way to the Prosteneek, where the main

roads once crossed the Moselle metropolis. The 15th-century nobleman Peter von Osburg's House, the Trier Gate, and the old townhouse are all must-sees before you return to the ship.

Duration: approx. 3 h *Walking grade: ●●●* € 45,00

EXCURSION TO LUXEMBOURG

From Grevenmacher, a comfortable coach will take you to the capital of the Grand Duchy of Luxembourg, one of the smallest countries in the world and the second smallest country in the European Union. Pass the Constitution Square (Place de la Constitution), the Grand Ducal Palace, and the Kirchberg Plateau, Luxembourg's banking and financial center business district. Not to be missed is the lively railroad station district, best known for its varied architectural styles.

Duration: approx. 4 h *Walking grade: ●●* € 54,00

THE NETHERLANDS

AMSTERDAM & ICONIC CANAL CRUISE

Founded as a small fishing village in the late 12th century, Amsterdam became one of the most important ports in the world during the Dutch Golden Age due to its innovative developments in trade. Today, the city has one of Europe's most important historical centers, with about 7,500 registered historic works of architecture. The street pattern has been essentially unchanged since the 19th century. The center consists of 90 islands linked by 400 bridges. On the city tour through the Dutch metropolis, you will see the Royal Palace, numerous canals, and the Museum Quarter.

As there is no better way to see the city than cruising on the water, the tour concludes with a canal boat trip.

Duration: approx. 4 hrs *Walking grade: ●●●* € 68,00

A DUTCH TRIP TO WATERLAND

Drive through the Dutch Polder landscape to the old fishing village of Volendam, built on the shore of the former Zuiderzee. The Volendam houses are built very close together, forming the typical neighborhoods of the town. Stroll through the old village and see people still dressed in traditional costumes. Board your coach and drive out of Volendam and into the countryside to visit a local cheese farm. Learn how Dutch cheese is made and sample the local product. On your way back to the ship, enjoy a short walk through the quaint village of Edam (if the time allows), famous for its cheese. Given the town's narrow streets, the tour continues on foot to see the Carillon Tower, once part of a church that was destroyed in the 19th century. Walk to the cheese-weighing house and the Dam with its 18th-century town hall.

Duration: approx. 5 resp. 4 hrs *Walking grade: ●●●* € 57,00

AMSTERDAM WITH CANAL TRIP AND HOLLAND WATERLAND (from Amsterdam/to Utrecht)

Founded as a small fishing village in the late 12th century, Amsterdam became one of the most important ports in the world during the Dutch Golden Age due to its innovative developments in trade. Today, the city has one of the largest historic centers in Europe, with about 7,500 registered historic buildings. The street pattern has been essentially unchanged since the 19th century. The center consists of 90 islands linked by 400 bridges. On the city tour through the Dutch metropolis, you will see the Royal Palace, numerous canals, and the Museum Quarter. As there is no better way to see the city than cruising on the water, the tour will end with a canal cruise boat trip.

Afterward, drive through the Dutch Polder landscape to the old fishing village of Volendam. Its houses are built very close together, forming the typical neighborhoods of the town. Stroll through the old village and see people still dressed in traditional costumes.

Board your coach and drive out of Volendam into the countryside to visit a local cheese farm. Here, you will learn how Dutch cheese is made and sample the local product.

Duration: approx. 5 hrs *Walking grade: ●●●* € 78,00

HAARLEM – ART, HISTORY AND DUTCH LIFESTYLE

Haarlem is just a short drive outside Amsterdam. Once a major North Sea trading port surrounded by defensive walls, it retains its medieval character with picturesque cobblestone streets and gabled houses. With spectacular monuments dating back nearly 800 years, it's no wonder so many great artists of the Golden Age wanted to capture its beauty and atmosphere. Not only is it home to some of the best museums and world-famous artwork in the Netherlands, but it is also regularly voted one of the best shopping cities in the country. Walk with your guide through the old historic center of Haarlem with its beautiful "hofjes" (almshouses built around leafy courtyards). Visit the Cathedral of St. Bavo, located on the Great Market in the middle of Haarlem. The church was built by Catholics in 1245 and still dominates the Haarlem skyline. The main eye-catcher in the church is the impressive organ by Christian Müller of Lower Saxony. The organ dates back to 1738 and is the most reproduced instrument in the world. After visiting the church, you can enjoy some free time to explore the center on your own before returning to Amsterdam.

Duration: approx. 4 hrs *Walking grade: ●●●●* € 46,00

ARNHEM AND THE OPEN AIR MUSEUM

Drive through the city of Arnhem, known for the World War II battle operation "Market Garden." Drive past various spots associated with this event and then continue to the Open Air Museum in a beautiful wooded park on the outskirts of Arnhem. The museum contains over 80 historic houses, farmhouses, and mills and shows the visitors how ordinary Dutch people lived from 1700 – 1970. The varied events and performances during the season are exciting, such as traditional bread baking or cheese production.

Duration: approx. 3 hrs *Walking grade: ●●●* € 76,00

ARNHEM AND THE HISTORY OF WORLD WAR II

Drive through the city of Arnhem, known for the World War II battle operation "Market Garden." In September 1944, the British 1st Airborne Division and the Polish 1st Independent Parachute Brigade were tasked with securing the bridge at Arnhem, captured in the movie "A Bridge Too Far." You will drive past various spots associated with this event. You will then visit the fully renewed Airborne Museum in Oosterbeek, with exhibits covering the landings into Arnhem. The building was a hotel in mid-1944, but in September of that year, it became the headquarters of the British commander-in-chief, Major General Roy Urquhart, of the 1st Airborne Division. From here, Urquhart commanded Operation Market Garden – a dramatic battle in which 92 Polish, 1,482 British, and more than 1,800 German troops, along with almost 1,000 civilians, lost their lives. You can still feel the tension, the fear, and the hardships in the museum.

Duration: approx. 3 hrs *Walking grade: ●●●* € 76,00

VISIT TO THE KRÖLLER-MÜLLER-MUSEUM

(closed on Mondays)

North of Arnhem awaits the Hoge Veluwe National Park, the largest actively managed nature reserve in the Netherlands. It covers 5,400 hectares of forest, heath, moorland, and shifting sands. The great diversity of plants and animals provides a habitat for rare species. Together with the Kröller-Müller Museum, Sculpture Garden, and Sint Hubertus Hunting Lodge, the park forms a unique and internationally renowned combination of nature, art, and architecture. The Museum is famous for its second-largest collection of Vincent van Gogh paintings, such as the "Potato Eaters" and the "Café Terrace at Night." It also features works by Piet Mondrian, Paul Gauguin, and Pablo Picasso. The magnificent collection of sculptures is one of the largest in Europe and is displayed in an innovative way surrounded by nature.

Duration: approx. 4 hrs *Walking grade: ●●* € 93,00

DELTA WORKS EXPERIENCE AND VEERE WALKING TOUR

The Delta Works in Holland are considered an engineering wonder of the world and are an impressive example of how the Dutch live with and protect themselves against water.



After the devastating storm surge of 1953, which killed 1835 people in the Netherlands, it was decided to build the Delta Works. These consisted of 13 structures and formed the world's most significant storm surge barrier. Delve deep into the extraordinary history of this impressive structure and learn more about what happened during and after the 1953 flood during a visit to the Watersnoodmuseum (or Flood Museum).

Before returning to your ship, stop in the beautiful town of Veere, a thriving trading port in the Middle Ages due to the wool trade with Scotland. Today Veere is a tourist attraction as it is one of the most worthwhile towns in the area.

Duration: approx. 4,5 hrs *Walking grade: ●●●* € 113,00

KINDERDIJK AND VISIT TO THE WINDMILLS

Holland is famous for its traditional windmills, of which more than 1,000 still exist today. The most extensive collection of windmills can be found near Kinderdijk. This is a group of 19 well-preserved windmills built around 1740.

Visit one of the old mills and learn more about the work of the mills in the past and the changes due to modern technology.

Duration: approx. 4 hrs *Walking grade: ●●●●* € 88,00

VISIT TO THE KEUKENHOF FLOWER GARDENS

(from/to Rotterdam)

After we leave the ship, we drive toward one of Europe's largest garden displays, the Keukenhof Gardens, the showplace of the tulip growers of the Netherlands. Art, royal flair, and creative diversity meet in this park. Keukenhof is not open all year round but only in late March, April, and the beginning of May. Seven million tulips, narcissi, and hyacinths form a colorful carpet of blooms. Round, oval, triangular, and rectangular borders line the park's driveways, making a cheerful ensemble of colors, shapes, and scents. Alternating exhibitions, known as parades, bloom in several pavilions. Numerous sculptures also lurk between the flowerbeds, as harmony between art and nature is a significant feature of this park.

Duration: approx. 4,5 hrs *Walking grade: ●●* € 94,00

MIDDELBURG WALKING TOUR

The capital of the province of Zeeland has about 1,100 large and small monuments, which testify to its rich past. The powerful abbey, the late-gothic town hall, and the splendid old warehouses let you relive this past. When walking through the dreamy streets, one can't believe that the entire city center was pretty much bombed during the Second World War. The city was rebuilt in the same style; today, one can still feel what life must have been like during the 16th century.

Duration: approx. 2 hrs *Walking grade: ●●●●* € 25,00



Luxembourg

© LFT | Christopher van Bie



© Christian Balenoi/Shutterstock.com

Bucharest: Palace of the Parliament

ROMANIA

BUCHAREST "PARIS OF THE EAST" AND DINNER (from Oltenița/to Fetești)

This full-day excursion explores the capital city of Romania, also known as the "Paris of the East." Driving along the city's magnificent boulevards, lined with landmark buildings, you will discover its French flair. A short guided walk through the lively pedestrian area of the historic center will take you back in time to 500 years. Among the old commercial streets and buildings, you shall visit one of the oldest churches in the city, Stavropoleos, which is Romanian Orthodox, dating back to 1724. The tour ends with a photo stop at the opulent Palace of the Parliament, constructed between 1983 and 1989. The palace, previously known as the "People's House," is one of the most significant buildings in Europe. Enjoy dinner in a Romanian restaurant before departing the city to join the ship.

Duration: approx. 7,5 hrs Walking grade: ●● € 109,00

BUCHAREST "PARIS OF THE EAST" AND LUNCH (from Fetești/to Bucharest)

A two-hour coach ride takes you past fields upon fields of sunflowers, wheat, corn, barley, and sugar beets to the capital city of Romania, also known as the "Paris of the East." Begin with a guided walk through the partly renovated traffic-free area in the historic center and visit one of the oldest Orthodox churches in the city: Stavropoleos, dating back to 1724. Its most striking feature is the portico with trilobed arches. Before enjoying a traditional lunch in a Romanian restaurant, choose your souvenir to carry home in one of the many shops. The subsequent bus tour takes you past the Opera House, the Medicine Faculty, and the Cotroceni Palace, along magnificent boulevards lined with landmark buildings and monuments, which give the city a certain French flair.

Conclude with a photo stop at the Palace of the Parliament, constructed between 1983 and 1989. Previously known as the "People's House," it is the second-largest administrative building in the world.

Duration: approx. 7,5 hrs Walking grade: ●●● € 109,00

BUCHAREST "PARIS OF THE EAST" AND LUNCH (from Bucharest/to Fetești)

Explore the capital city of Romania, also known as the "Paris of the East." The tour takes you past the Opera House, the Medicine Faculty, and the Cotroceni Palace. Continue along magnificent boulevards lined with landmark buildings, which give the metropolis a certain French flair.

Afterward, take a guided walk through the partly rebuilt pedestrian area. Visit the Stavropoleos Church (dating back to 1724), one of the city's oldest Orthodox churches. Take a shopping expedition to buy gifts and souvenirs. Before the traditional lunch in a Romanian

restaurant, prepare your cameras for a photo of the largest administrative building in the world: the Palace of the Parliament, built during the golden age of the dictatorial regime.

On your way to the vessel, view fields upon fields of sunflower, wheat, and corn during the two-hour coach ride to Fetești. The picturesque Romanian plain is the central granary of this country, with the most pronounced agrarian profile in the European Union.

Duration: approx. 7,5 hrs Walking grade: ●●● € 109,00

DANUBE DELTA NATURE EXPERIENCE

Experience the Danube Delta Biosphere Reserve, the second largest delta in Europe and covers an area of 5,800 km², of which 72% with an area of 4,178 km² are under protection.

Your journey begins at the end of the oldest and wildest arm of the Danube, in a small fishing village called Sfintu Gheorghe (St. George). Take small boats to access the Sahalin Lagoon, the Ciotica Channel, and pass by the oldest fish-processing center in the Danube Delta. Discover the largest reed-covered area in the world, a unique habitat for birds and fish, still largely untouched in its beauty.

Duration: approx. 2 hrs Walking grade: ●● € 64,00

CONSTANȚA ARCHEOLOGY AND BLACK SEA COAST

Constanța is Romania's biggest port and its longest continually inhabited city, founded by Greek colonists in the 6th century BC. Walking along the seaside promenade, see the timeworn Casino right on the waterfront of the Black Sea. Once an opulent Art Nouveau hotspot, it is now one of Romania's most beautiful abandoned buildings. Pass by the Great Mosque and the Genovese Lighthouse in the historic center. A short visit to the History and Archaeology Museum will reveal the city's 2.5 millennia history and detail its blend of cultures. Step on the golden sandy beaches of the Black Sea before returning to the ship.

Duration: approx. 5 hrs Walking grade: ●●● € 67,00

SERBIA

DYNAMIC BELGRADE & KALEMEGDAN FORTRESS

Belgrade, one of the oldest European cities and the capital of Serbia, lies at the junction of the Danube and the Sava. The city boasts a large number of monuments from different areas and different cultures.

First, the tour takes you to the Kalemegdan Fortress, where you'll have an impressive panoramic view over the Danube and the Sava Rivers. Afterward, you can see the National Museum, the parliament, the Terazije Square, and the Palace of Princess Ljubica.

After a refreshment break at a local restaurant, our tour ends in the pedestrian area, where you will find many shops and art galleries.

Duration: approx. 3,5 hrs Walking grade: ●● € 46,00

KOVAČICA – RURAL SERBIA

The colorful artists' village of Kovačica is a unique oasis of preserved traditions, original art, and crafts. It has kept its identity alive and gained worldwide fame due to its traditional naive painting. This style reflects nature, peace, and lifestyle with plenty of color and detail. Famous painters of naive art are Zuzana Halupova and Martin Jonas.

Continue with a visit to the Slovak – Evangelical Church, built in the late Baroque style. Its interior is enriched by a monumental altar with a painting by Constantine Danilo.

The tour's final stop is the violin maker's studio: Jan Nemček is a self-taught master artisan who builds violins by hand. With skillful hands, Jan cuts and dries the wood and then slowly and patiently fashions it into a treat for the eye and the musical soul.

Duration: approx. 3 hrs Walking grade: ●●● € 34,00

NOVI SAD AND SREMSKI KARLOVCI

A stroll through the second-largest city in Serbia recalls the time of the Austro-Hungarian monarchy. Marvel at the Catholic St. Mary's Church, the Orthodox Church of St. George, and the house where Albert Einstein once lived. On the way to Sremski Karlovci, you will

pass the fortress Peterwardein, built by the French architect Vauban and was one of Europe's most significant defense structures in the 18th century. Sremski Karlovci awaits you with a series of cultural and historical monuments.

Duration: approx. 3 hrs Walking grade: ●● € 46,00

SKADARLIJA, THE ARTISTS' QUARTER

A coach takes you through the illuminated Belgrade by night to a hotel in the city center, where you will enjoy a splendid folklore show. The ensemble will invite you for a glass of wine and perform dances from around the country. The traditional costumes are hand-made and colorful, and various pieces of Serbian folk music will be performed. Then you will drive to Skadarlija, the famous artists' quarter, also known as the Montmartre of Belgrade. A Serbian band will serve you Serbian specialties and live music.

Duration: approx. 3 hrs Walking grade: ● € 64,00

TOPOLA, OPLENAC AND THE SERBIAN ROYAL DYNASTY

Depart from Belgrade by bus towards the south. Cross the picturesque landscapes of Šumadija, a region of central Serbia, to the city of Topola, the site of the First Serbian Insurrection against Ottoman rule in 1804. The small town of Topola lies at the foot of the hill of Oplenac, which is covered by an oak and poplar forest. Visit the mansion of Karadjordje, the Serbian duke who led the revolt. Go to the top of the hill of Oplenac and see the Serbian King Peter I house and St. George's Church, built to serve as the mausoleum of the Serbian royal dynasty of Karadjordjevic. Enter the church and admire its interior, built in white marble and decorated with mosaics – Marvel at the richly decorated royal crypt, which now houses about 20 tombs of royal family members.

Duration: approx. 4,5 hrs Walking grade: ●●● € 46,00

SLOVAKIA

BRATISLAVA – BEAUTY ON THE DANUBE

Get to know the capital of the young Slovakian Republic. The tour passes St. Martin's Cathedral and the Grassalkovich Palace and continues up to the hill above the old town, where you will have a stunning, panoramic view of the city and surrounding areas.

Afterward, a guided walking tour leads you through the restored old town, which has maintained its Gothic-Baroque style. Take a stroll from Michael's Gate through the historic city center, admire sights such as the Primatial Palace and St. Martin's Cathedral, a former coronation cathedral for Hungarian kings, as well as the Academia Istropolitana, the oldest university of the city, dating back to the 15th century. See the main square with the old City Hall, the Opera House, and Maximilian Fountain.

Duration: approx. 3 hrs Walking grade: ●● € 45,00



Schloss Hof

© KB Herta Hurnaus

SCHLOSS HOF – BAROQUE PALACE AND ESTATE

A short coach ride takes you to Schloss Hof Palace and Estate in Austria. The magnificent complex was built in the early 18th century through the efforts of two of the most influential personalities of the Austrian Baroque period. Field Marshall Prince Eugene of Savoy was already a legend in his lifetime. An art enthusiast, he provided significant funding for constructing the castle. The brilliant architect Lucas von Hildebrandt created a virtuoso masterpiece comprising a palace, terraced gardens, and an idyllic country estate. Its subsequent owner, Empress Maria Theresia, added a story to the palatial building, which was remodeled in the style of French Classicism in accordance with the tastes of the time. The Estate is unique in Europe and has become a top destination for those who seek to delight in culture, nature, and the fascinating world of Baroque.

After visiting the inside of the castle, explore the flowery garden and the Maierhof farm, with its wealth of plants and animals.

Duration: approx. 5 hrs Walking grade: ●●● € 67,00

VISIT TO SCHLOSS HOF PALACE AND ESTATE (from Bratislava/to Hainburg)

Travel by coach along the Marchfelder Schösserstraße to Hof Castle in Austria. The magnificent complex was built in the early 18th century through the efforts of two of the most influential personalities of the Austrian Baroque period. Field Marshall Prince Eugene of Savoy was already a legend in his lifetime. An art enthusiast, he provided significant funding for constructing the castle. The brilliant architect Lucas von Hildebrandt created a virtuoso masterpiece comprising a palace, terraced gardens, and an idyllic country estate. Its subsequent owner, Empress Maria Theresia, added a story to the palatial building, which was remodeled in the style of French Classicism in accordance with the tastes of the time. The Estate is unique in Europe and has become a top destination for those who seek to delight in culture, nature, and the fascinating world of Baroque.

Duration: approx. 3 hrs Walking grade: ●●● € 67,00

THE LITTLE CARPATHIAN WINE ROUTE

Enjoy a scenic drive through the Little Carpathian mountain range. This protected forested mountain range stretches from Bratislava to the northeast for 62 miles. Many wineries with a long winemaking tradition dating back to the Celtic and Roman settlements are dotted along the Little Carpathians. These villages, such as Svätý Jur (St. George), Pezinok, or Modra, supplied the royal court with good Little Carpathian wines since the Middle Ages. Along the route are artisan towns with long traditions such as pottery and other handicrafts. On your return drive, enjoy a wine tasting of the local vintage in a wine cellar, where you will also learn about the history of wine growing in the Little Carpathians.

Duration: approx. 4,5 hrs Walking grade: ●●● € 61,00

SWITZERLAND

BASEL – WHERE THREE COUNTRIES MEET

Let this city captivate you with its charm. After a short drive that includes the city's ring road with its famous Spalen gateway, you will discover Basel during a 90-minute walking tour. The authentic medieval appearance of Basel's historic quarter never fails to delight travelers and residents alike. The cathedral, the glorious guild halls, manor houses, and numerous historic buildings all witness the ecclesiastical and secular wealth that has survived here to this day.

Walk up to the splendid Münster Hill, see notable sights, and then enjoy a breathtaking view over the Rhine. The walk ends in the city's heart, at the marketplace in front of the red brick city hall.

Before the coach takes you back to the ship, there'll still be sufficient free time to look around a little independently.

Duration: approx. 3 hrs Walking grade: ●●● € 91,00

General Terms and Conditions of Travel 2024

PREAMBLE:

These travel conditions are issued in the name of the carrier, Lüftner Cruises GmbH / A-6020 Innsbruck, for the travel programs included in this brochure. Lüftner Cruises GmbH also does business under the trade name Lüftner Cruises. In the following, these are referred to as "the carrier". These terms and conditions of travel apply to programs listed under either name. The transportation of passengers and baggage on any of the vessels offered is governed solely by the Terms and Conditions of the Passenger Ticket Contract (available on request).

WITHDRAWAL AND TERMINATION BY THE CARRIER:

The carrier may withdraw from the travel contract before the cruise starts or terminate it after the cruise has begun in the following cases, without the carrier being liable for any claims, particularly not for damages:

- a) The carrier and its representatives on board have the right to prohibit passengers from remaining on board if, despite prior warning, they do not comply with the rules and regulations in force during the cruise, including, in particular, applicable hygiene and health measures, and orders and instructions by the ship's command, or if their behavior impairs the health and well-being of other passengers or crew, and/or the safety of the ship, or if their behavior harasses other passengers. All consequences arising therefrom shall be borne exclusively by the passenger themselves and they shall not be entitled to a refund of the cruise fare.
- b) if, by two (2) weeks prior to the start of the cruise, the advertised minimum number of participants has not been reached, which is 80 passengers per cruise or whatever other minimum number of participants has been indicated in the advertising for the service concerned. This also applies in the event that it becomes apparent at an earlier point in time that the minimum number of participants will not be reached.
- c) if, by four (4) weeks prior to the start of the cruise – with the carrier having exhausted all other possibilities – it would be unreasonable for the carrier to execute the cruise because the costs incurred in the execution of the cruise would exceed the economic limit in relation to this cruise; that is, unless the carrier itself is answerable for the main reasons leading to the situation concerned.

GUARANTEE, REDRESS AND DUTIES TO CO-OPERATE:

If travel services are not provided as contracted then the traveler may demand redress, either directly on board or via his/her travel agency. Irrespective of the carrier's overriding duty to provide service, the traveler has a duty to co-operate in that they must do whatever they can reasonably do to contribute to remedying the disruption and to keep any losses that may arise as low as possible or to avoid them completely. The traveler has a particular duty to advise the carrier's representative on board (specifically the hotel manager, cruise director) immediately of any possible complaints. However, these persons are not authorized to deal with any claims.

CHANGES IN SERVICES AND PRICES:

- a) Changes and deviations of individual travel services from the agreed tour contract (for example, timetable changes, changes to scheduled sequences, or to hotel reservations) that become necessary after conclusion of the contract, and where there is no evidence of bad faith on the part of the carrier, are permissible, provided they are not significant changes and do not alter the overall tour program.
- b) The carrier reserves the right to alter the prices mentioned in the case of transportation price increases (particularly due to rises in fuel costs), docking fees, or due to fluctuating exchange rates, or to any other rises in prices /costs that were not known at the time of the completion of the booking contract.

ACTS OF GOD, STRIKES, OR OTHER CONDITIONS BEYOND CONTROL:

a) Before the cruise starts: If execution of the cruise is made more difficult, jeopardized or impaired as a result of extraordinary circumstances that were unforeseeable at the time of entering into the contract and out of the control of the carrier, such as war, strikes, civil unrest, sovereign directives (such as the requisition of accommodation or of means of transportation), embargoes, natural disasters, accidents, epidemics, pandemics, damage to the vessel (especially to the hull and engines, etc.), or other occurrences that are equivalent in their effect to the examples mentioned above (force majeure), the contracting parties may withdraw from the contract before the start of the trip, without any claims against the carrier arising from this, in particular for damages.

b) After the cruise has begun: If the circumstances specified above come about after the cruise has begun and the cruise is ultimately delayed, then the carrier is authorized to reconstruct the remaining journey such that other routes or means of transport are organized, for example, by avoiding a harbor, or by traveling overland, so that the journey can be ended at approximately the original time specified. In such a case, the tour price will not be reduced and the carrier will not be liable for claims, particularly not claims for damages.

c) Termination of a cruise: Should a cruise have to be terminated due to any of the abovementioned circumstances, the carrier is authorized to transport passengers and their baggage by alternate means of transport (such as by train, bus or plane) to the agreed starting or end point of the cruise, or to an appropriate intermediate point with suitable means of transport. The carrier is not

d) Ship in distress: Should another vessel be in need of the cruise ship's assistance during a cruise, then the carrier is not liable for any delays caused by the assistance rendered or by any rescue operation. The decisions regarding such possible assistance rest solely with the ship's captain. The carrier will not be liable for claims, particularly not claims for damages.

e) Changes in the water level: Unusually low or high river water levels may cause changes to the itinerary, possible re-embarkation onto another vessel or transfer(s) by coach or rail, or may even lead to a shortening of the journey. The carrier and the ship's captain sometimes have to take such decisions quickly. Such measures do not justify withdrawal from the contract by the person traveling and the carrier is not

UNUSED SERVICES:

If as a result of an early return or for other reasons, passengers do not make use of individual cruise services that were properly offered, there is no entitlement to a pro rata refund of the cruise price. The carrier will, however, make an effort to obtain reimbursement for the expenses saved from relevant service providers. This obligation does not apply if the services in question are insignificant.

PASSPORTS, VISAS, CUSTOMS, CURRENCIES AND HEALTH REGULATIONS:

The traveler is solely responsible for compliance with all matters regarding travel-related regulations and prerequisites. Any interruptions resulting from noncompliance with such regulations will be at the expense of the traveler, unless caused by intentional misinformation by the carrier.

INSURANCE BOND:

Lüftner Cruises GmbH is listed in the carrier directory of the Austrian Ministry for Economics, Family and Youth under number 2004/0052. In accordance with the travel agency insurance ordinance applicable to Austrian carriers (Reisebürosicherungsverordnung – RSV), Lüftner

Cruises GmbH insures customer money received. Further information regarding this travel security and on the assertion of rights, deadlines, etc., and on claim exclusions can be obtained from the travel agency handling the reservation.

TRAVEL INSURANCE:

For your own safety, it is advisable to take out an insurance policy in good time, covering, in particular, possible cancellation costs as well as damage and/or loss of your luggage, costs for possible medical treatment, repatriation services, etc.

CHILDREN/MINORS:

Due to the particular features of the cruise programs, special provisions apply to bookings with children and minors:
– The carrier may limit the number of passengers under 3 years of age.
– Passengers up to the age of 16 must be accompanied by and share a cabin with a parent, guardian or other responsible adult over the age of 21. Parents and guardians are responsible for the behavior and appropriate supervision of their accompanying children and minor(s) throughout their vacation.

PASSENGERS WITH SPECIAL NEEDS:

The carrier does not discriminate against persons with special needs. All means of transport used during these programs comply with European standards. Most of the vessels have lifts that allow for easy access between decks (except for the Sun Deck). However, the route between the ship and the shore, in particular, may have major obstacles that must be overcome by all passengers without the use of, for example, a wheelchair. Likewise, property in connection with third-party services that were disclosed as such.

For this reason, persons with special needs must inform themselves as to whether it is possible for them to take part in the trip and/or obtain the carrier's consent before making a booking. In addition, for safety reasons, the transportation of wheelchairs may be prohibited by the ship's management. A claim against the carrier, in particular for damages, cannot arise from such non-admission.

LIABILITY/LIMITATION OF LIABILITY/DISCLAIMERS:

- a) The carrier is liable for services which are included in the description of the respective cruise.
- b) The carrier is not liable for any service disruptions, damages to persons and/or not all the ports, buses, etc. that are used have suitable facilities.
- c) The carrier expressly refers to possible liability limitations and exemptions relevant under the Strasbourg Convention on the Limitation of Liability of Owners of Inland Navigation Vehicles (CLNI), including protocols and amendments, together with the further provisions of the International Convention of Limitation of Liability for Maritime Claims, 1976, likewise including amendments and addenda, if and as applicable, as well as all further state laws applicable in this respect.

This is a translation from the original General Terms & Conditions "Geschäftsbedingungen" of Lüftner Cruises GmbH in German. The above translation is provided solely as a courtesy and convenience but in all cases, the meaning and intent of the original General Terms & Conditions in German shall prevail at all times.

The General Terms & Conditions shall be covered exclusively by Austrian law with jurisdiction in Innsbruck, Austria.

CARRIER:

Lüftner Cruises GmbH
Menardi Center
Amraser See Strasse 56
6020 Innsbruck, Austria



Important Information

AIR CONDITIONING: Please note that the air conditioning in your cabin is only effective if doors and windows are kept closed. Air conditioning can be regulated individually in each cabin.

ANNOUNCEMENTS: A public address system enables our Cruise Directors to provide important information about places we are passing, the onboard program and shore excursions. You can hear these announcements on the Sun Deck, in your cabin, and in all public areas of the vessel.

CHANGING MONEY: Please inform yourself of the currency regulations in the countries you are visiting before commencing your journey.

CLOTHING: By day and during shore excursions, we recommend casual clothing and comfortable footwear. A jacket or pullover may be required in the evening. For dinner and special occasions we recommend dressing smartly.

CRUISE DIRECTOR'S TEAM: The Cruise Director's team will look after you throughout the cruise and is happy to provide any additional information you require.

CRUISE ITINERARIES: Although every effort is made to keep itineraries as advertised, we reserve the right to make changes and substitutions as necessary to ensure the safety of our guests and our vessels. Due to force majeure, high or low water, and technical problems relating to the ship, as well as waterway infrastructure, waiting times at locks due to traffic, etc., changes may occur. In such cases, you will be immediately informed on board about the consequences.

DAILY PROGRAM: A Daily Program is placed in your cabin on the previous evening. It contains important information such as meal times, as well as the timing for excursions and other events.

DECKCHAIRS: There are plenty of deckchairs on the Sun Deck which are available free of charge.

DINING: The onboard restaurant accommodates all guests in one sitting. The restaurant serves both local and international dishes and a vegetarian option is always available. The Maitre D' will assist with seating.

DRINKING WATER: The ship has been outfitted with a sophisticated filtration system, and the tap water in each stateroom is safe to use.

ELECTRIC CURRENT: The voltage on board ship is 230 V, European standard. To use any electrical product that is not dual voltage (e.g. from the US, Canada, Australia or the UK), you will need a plug adaptor and some devices will require a voltage converter. A two-pole adaptor is available at reception.

ELEVATOR: All AMADEUS vessels in this brochure are equipped with an elevator that services all decks except the Sun Deck.

DOCKING: Local river authorities allocate docking space around ship arrivals/departures in port. Occasionally port conditions require ships to tie up alongside each other, in which case guests may be required to walk through another ship to access their own ship. This is part of the river cruise experience and is perfectly normal and beyond our control. Guests may experience obstructed views from staterooms when the ship is docked.

ENTERTAINMENT PROGRAM: The schedule for the onboard entertainment may be found in the Daily Program.

EXCURSION PROGRAM: Excursion packages can be purchased at a discounted rate before the start of your cruise. Excursions can be booked on board either individually or as a package at the cost specified in the travel catalogue. You will receive a description of the excursions with your travel documents before the start of your cruise. Should you have any further questions, please contact the Cruise Director on board. Where possible, shore excursions will be conducted in one language only, provided there is a minimum of 20 participants.

FAMILY RATE: Die *AMADEUS Nova, Imperial, Riva, Queen, Provence* and *Silver III* have a limited number of C-1, C-4 resp. B-4 cabins with connecting doors, which can be booked on request for 2 adults with 1 or 2 children.

FITNESS: A fitness room is open 24 hours a day on every AMADEUS vessel.

GIFT SHOP: This shop offers exclusive AMADEUS branded items, as well as souvenirs, postcards, stamps, accessories and some everyday essentials.

GRATUITIES: Gratuities are a common way for guests to express their satisfaction with the cruise staff. If you are happy with the service you receive, our staff will appreciate tips in recognition of their effort. You will receive further information on board.

HEALTH: Please inform your travel agent if you require special medical arrangements on board. We reserve the right to refuse such requirements. For passengers with special needs, please refer to the regulations in the General Conditions of Travel.

INSURANCE: While travel insurance is not required in order to participate in this program, we recommend that each guest purchase a travel protection plan, as unforeseen circumstances can occur both prior to and during travel.

INTERNET/WIFI: All AMADEUS ships have wireless Internet/WLAN. We ask for your understanding that the connection may be weaker on certain sections of the route. In addition, there may be short interruptions when national borders are crossed. The staff on board can provide more detailed information on this.

LAUNDRY SERVICE: A laundry service is available on board for a nominal fee. Please note that neither self-service laundry facilities nor dry cleaning services are available.

LIBRARY: There is a selection of light reading material available for your use on board. Whenever possible, daily newspapers are also made available. At the end of the cruise we ask you kindly to return any books or magazines you have borrowed.

MEDICATION: If you require any special medication, please ensure that you have an adequate supply before joining the cruise. The onboard pharmacy is equipped for emergencies.

ONBOARD ACCOUNT: Your account will include your personal expenditures in the bar, restaurant, onboard shop, etc. At the end of the cruise, you will be presented with a bill for settlement prior to disembarkation.

ONBOARD CURRENCY: The currency on board is the EURO.

PAYMENT METHODS: The following payment methods are accepted for the payment of shore excursions and the settlement of your onboard account: cash in the form of Euros, Swiss francs (CHF), British pounds (GBP), US dollars (USD) and Norwegian krone (NOK), as well as Maestro bank cards and common credit cards such as American Express, Visa, MasterCard and Diners Club.

PETS: Pets are not permitted on board.

POSTAL SERVICE: Letters and postcards can be mailed through the Reception Desk. Mail will be sent from the next port of call.

SAFE: Please use the safe in your cabin to store valuables, cash, etc.

SERVICES NOT INCLUDED: Please see the travel description to determine which services are included. Tips and other personal expenses are not included.

SMOKING: For safety reasons, smoking is not permitted anywhere inside any AMADEUS vessel. Smoking is only permitted on the Sun Deck and on the River Terrace.

SPECIAL DIETARY NEEDS: If you have special dietary requirements or suffer from food allergies (e.g. lactose intolerance, gluten intolerance, etc.), please inform your travel agent at the time of booking. Our crew is experienced in carefully observing dietary needs. Please note, however, that while our crew will do their best to ensure that your request is accommodated, they are, of course, also responsible for the care of the other passengers on board. We reserve the right to refuse certain dietary requirements or to charge for them separately.

TRAVEL DOCUMENTS: Please check with your travel agent or respective embassy regarding the entry regulations of the respective countries before starting your cruise. If necessary, the reception desk will ask you to hand in your travel documents on embarkation in order to reduce the paperwork associated with border crossings as much as possible. All travel documents handed in will of course be stored safely.

TV CHANNELS: TV is received by satellite. In locks and on certain stretches of the river there may be slight interference/interruptions to the service.

Please note: Cruise programs, excursions, tour dates and prices are subject to change (Juli 2023). Please ask for the General Travel Conditions of Lüftner Cruises or visit our website at www.lueftner-cruises.com

No responsibility is assumed for the correctness, completeness or quality of the information provided by our service partners.

2024 Cruise Planner

MARCH	Name	Cruise	Page
28.03.–04.04.	Burgundy & Provence	Lyon – Chalon-s.S. – Lyon	88
30.03.–06.04.	Tulip Serenade	Amsterdam – Amsterdam	22
APRIL	Name	Cruise	Page
02.04.–09.04.	Klassischer Rhein	Amsterdam – Basel	26
02.04.–09.04.	Danube Rhapsody	Passau – Budapest – Passau	64
03.04.–10.04.	Paris, Normandy/Seine	Paris – Le Havre – Paris	84
04.04.–11.04.	Burgundy & Provence	Lyon – Chalon-s.S. – Lyon	88
06.04.–13.04.	Tulip Serenade	Amsterdam – Amsterdam	22
09.04.–16.04.	Classical Rhine	Basel – Amsterdam	26
09.04.–16.04.	Classical Danube	Passau – Budapest	58
10.04.–17.04.	Paris, Normandy/Seine	Paris – Le Havre – Paris	84
11.04.–18.04.	Burgundy & Provence	Lyon – Chalon-s.S. – Lyon	88
16.04.–23.04.	Tulip Serenade	Amsterdam – Amsterdam	22
18.04.–25.04.	Burgundy & Provence	Lyon – Chalon-s.S. – Lyon	88
21.04.–28.04.	Tulip Serenade	Amsterdam – Amsterdam	22
23.04.–08.05.	Danube/Danube delta	Passau – Delta – Passau	72
24.04.–01.05.	Paris, Normandy/Seine	Paris – Le Havre – Paris	84
25.04.–02.05.	Burgundy & Provence	Lyon – Chalon-s.S. – Lyon	88
28.04.–05.05.	Tulip Serenade	Amsterdam – Amsterdam	22
MAY	Name	Cruise	Page
02.05.–09.05.	Tulip Serenade	Amsterdam – Amsterdam	22
02.05.–09.05.	Burgundy & Provence	Lyon – Chalon-s.S. – Lyon	88
04.05.–11.05.	Classical Rhine	Amsterdam – Basel	26
09.05.–16.05.	Three-Rivers Cruise	Amsterdam – Nuremberg	32
09.05.–23.05.	Across Europe	Amsterdam – Budapest	52
09.05.–16.05.	Burgundy & Provence	Lyon – Chalon-s.S. – Lyon	88
10.05.–17.05.	Saar & Moselle Fairytales	Cologne – Saarlouis – Cologne	36
12.05.–19.05.	Classical Rhine	Basel – Amsterdam	26
16.05.–23.05.	Blue Danube	Nuremberg – Budapest	68
19.05.–26.05.	Classical Rhine	Amsterdam – Basel	26
21.05.–28.05.	Classical Danube	Budapest – Passau	58
23.05.–30.05.	Burgundy & Provence	Lyon – Chalon-s.S. – Lyon	88
25.05.–01.06.	Classical Rhine	Basel – Amsterdam	26
26.05.–02.06.	Classical Rhine	Basel – Amsterdam	26
29.05.–05.06.	Paris, Normandy/Seine	Paris – Le Havre – Paris	84
JUNI	Name	Cruise	Page
04.06.–11.06.	Classical Danube	Passau – Budapest	58
07.06.–14.06.	Danube Rhapsody	Passau – Budapest – Passau	64
07.06.–14.06.	Paris, Normandy/Seine	Paris – Le Havre – Paris	84
09.06.–16.06.	Classical Rhine	Basel – Amsterdam	26
12.06.–19.06.	Paris, Normandy/Seine	Paris – Le Havre – Paris	84
13.06.–20.06.	Burgundy & Provence	Lyon – Chalon-s.S. – Lyon	88
14.06.–22.06.	German Riverscapes	Passau – Trier	46
15.06.–22.06.	Danube Rhapsody	Passau – Budapest – Passau	64
16.06.–23.06.	Classical Rhine	Amsterdam – Basel	26
20.06.–27.06.	Burgundy & Provence	Lyon – Chalon-s.S. – Lyon	88
26.06.–03.07.	Paris, Normandy/Seine	Paris – Le Havre – Paris	84
27.06.–04.07.	Burgundy & Provence	Lyon – Chalon-s.S. – Lyon	88
28.06.–05.07.	Rhine/Danube Symphony	Cologne – Passau	40
29.06.–06.07.	Classical Rhine	Amsterdam – Basel	26
JULY	Name	Cruise	Page
06.07.–13.07.	Classical Danube	Passau – Budapest	58
06.07.–13.07.	Classical Rhine	Basel – Amsterdam	26
07.07.–14.07.	Classical Danube	Budapest – Passau	58
13.07.–20.07.	Classical Rhine	Amsterdam – Basel	26
14.07.–21.07.	Danube Rhapsody	Passau – Budapest – Passau	64
15.07.–22.07.	Classical Rhine	Amsterdam – Basel	26
15.07.–30.07.	Danube/Danube delta	Passau – Delta – Passau	72
17.07.–24.07.	Classical Rhine	Basel – Amsterdam	26
17.07.–24.07.	Paris, Normandy/Seine	Paris – Le Havre – Paris	84
21.07.–28.07.	Danube Rhapsody	Passau – Budapest – Passau	64
22.07.–29.07.	Classical Rhine	Basel – Amsterdam	26
27.07.–03.08.	Three-Rivers Cruise	Amsterdam – Nuremberg	32
27.07.–03.08.	Across Europe	Amsterdam – Budapest	52
28.07.–06.08.	1,200 Miles/Danube	Vienna – Delta – Bucharest	76
30.07.–06.08.	Danube Rhapsody	Passau – Budapest – Passau	64

Color coding: ■ Holland and Belgium ■ Rhine and Tributaries ■ Rhine and Danube ■ Danube · Danube Delta ■ Seine ■ Rhône · Saône ■ Golf Cruises ■ Winter Cruises

AUGUST	Name	Cruise	Page
03.08.–10.08.	Blue Danube	Nuremberg – Budapest	68
04.08.–14.08.	1,200 Miles/Danube	Bucharest – Delta – Vienna	76
06.08.–14.08.	German Riverscapes	Passau – Trier	46
07.08.–14.08.	Classical Rhine	Amsterdam – Basel	26
08.08.–15.08.	Burgundy & Provence	Lyon – Chalon-s.S. – Lyon	88
10.08.–17.08.	Classical Danube	Budapest – Passau	58
14.08.–22.08.	German Riverscapes	Trier – Passau	46
14.08.–21.08.	Paris, Normandy/Seine	Paris – Le Havre – Paris	84
21.08.–28.08.	Classical Danube	Passau – Budapest	58
22.08.–29.08.	Rhine/Danube Symphony	Passau – Cologne	40
22.08.–29.08.	Danube Rhapsody	Passau – Budapest – Passau	64
29.08.–04.09.	Classical Rhine	Basel – Amsterdam	26
28.08.–05.09.	Saar & Moselle Fairytales	Cologne – Saarlouis – Cologne	36
SEPTEMBER	Name	Cruise	Page
04.09.–11.09.	Paris, Normandy/Seine	Paris – Le Havre – Paris	84
08.09.–23.09.	1.200 Meilen/Donau	Passau – Delta – Passau	76
11.09.–14.09.	Classical Rhine	Basel – Amsterdam	26
11.09.–18.09.	Classical Danube	Budapest – Passau	58
12.09.–19.09.	Danube Rhapsody	Passau – Budapest – Passau	64
18.09.–25.09.	Paris, Normandy/Seine	Paris – Le Havre – Paris	84
19.09.–26.09.	Rhine/Danube Symphony	Cologne – Passau	40
19.09.–26.09.	Burgundy & Provence	Lyon – Chalon-s.S. – Lyon	88
21.09.–28.09.	Classical Rhine	Amsterdam – Basel	26
23.09.–08.10.	Danube/Danube delta	Passau – Delta – Passau	72
26.09.–03.10.	Danube Rhapsody	Passau – Budapest – Passau	64
26.09.–03.10.	Burgundy & Provence	Lyon – Chalon-s.S. – Lyon	88
28.09.–05.10.	Classical Rhine	Basel – Amsterdam	26
28.09.–05.10.	Saar & Moselle Fairytales	Cologne – Saarlouis – Cologne	36
OCTOBER	Name	Cruise	Page
02.10.–09.10.	Danube Rhapsody	Passau – Budapest – Passau	64
02.10.–09.10.	Paris, Normandy/Seine	Paris – Le Havre – Paris	84
02.10.–09.10.	Golf Cruise/Seine	Paris – Le Havre – Paris	98
05.10.–12.10.	Classical Rhine	Amsterdam – Basel	26
05.10.–12.10.	Rhine/Danube Symphony	Cologne – Passau	40
09.10.–16.10.	Classical Danube	Passau – Budapest	58
09.10.–18.10.	1,200 Miles/Danube	Vienna – Delta – Bucharest	76
10.10.–17.10.	Burgundy & Provence	Lyon – Chalon-s.S. – Lyon	88
12.10.–19.10.	Classical Rhine	Basel – Amsterdam	26
12.10.–19.10.	Golf Cruise/Rhine	Basel – Amsterdam	94
12.10.–19.10.	Danube Rhapsody	Passau – Budapest – Passau	64
16.10.–23.10.	Classical Danube	Budapest – Passau	58
16.10.–23.10.	Golf Cruise/Danube	Budapest – Passau	96
16.10.–26.10.	1,200 Miles/Danube	Bukarest – Delta – Vienna	76
17.10.–24.10.	Burgundy & Provence	Lyon – Chalon-s.S. – Lyon	88
19.10.–26.10.	Danube Rhapsody	Passau – Budapest – Passau	64
19.10.–26.10.	Classical Rhine	Amsterdam – Basel	26
24.10.–31.10.	Burgundy & Provence	Lyon – Chalon-s.S. – Lyon	88
26.10.–02.11.	Classical Rhine	Basel – Amsterdam	26
31.10.–07.11.	Burgundy & Provence	Lyon – Chalon-s.S. – Lyon	88
NOVEMBER	Name	Cruise	Page
28.11.–05.12.	Magic of Advent	Vienna – Nuremberg	106
DECEMBER	Name	Cruise	Page
01.12.–05.12.	Magic of Advent	Strasbourg – Cologne	104
02.12.–08.12.	Magic of Advent	Strasbourg – Nuremberg	102
09.12.–13.12.	Magic of Advent	Cologne – Strasbourg	104
10.12.–16.12.	Magic of Advent	Vienna – Nuremberg	106
13.12.–17.12.	Magic of Advent	Strasbourg – Cologne	104
14.12.–20.12.	Magic of Advent	Nuremberg – Vienna	106
22.12.–28.12.	Christmas Cruise	Cologne – Strasbourg – Cologne	110
22.12.–28.12.	Christmas Cruise	Passau – Bratislava – Passau	112
28.12.–04.01.	New Year's Eve Cruise	Cologne – Basel – Cologne	114
29.12.–04.01.	New Year's Eve Cruise	Passau – Budapest – Passau	116



LÜFTNER *LC* CRUISES

TMG / SEAGNATURE.COM
Tel. 00 377 97 98 41 31